

Amana DG6161 03 - 159P3 SIDE EXHAUST DEFLECTOR KIT

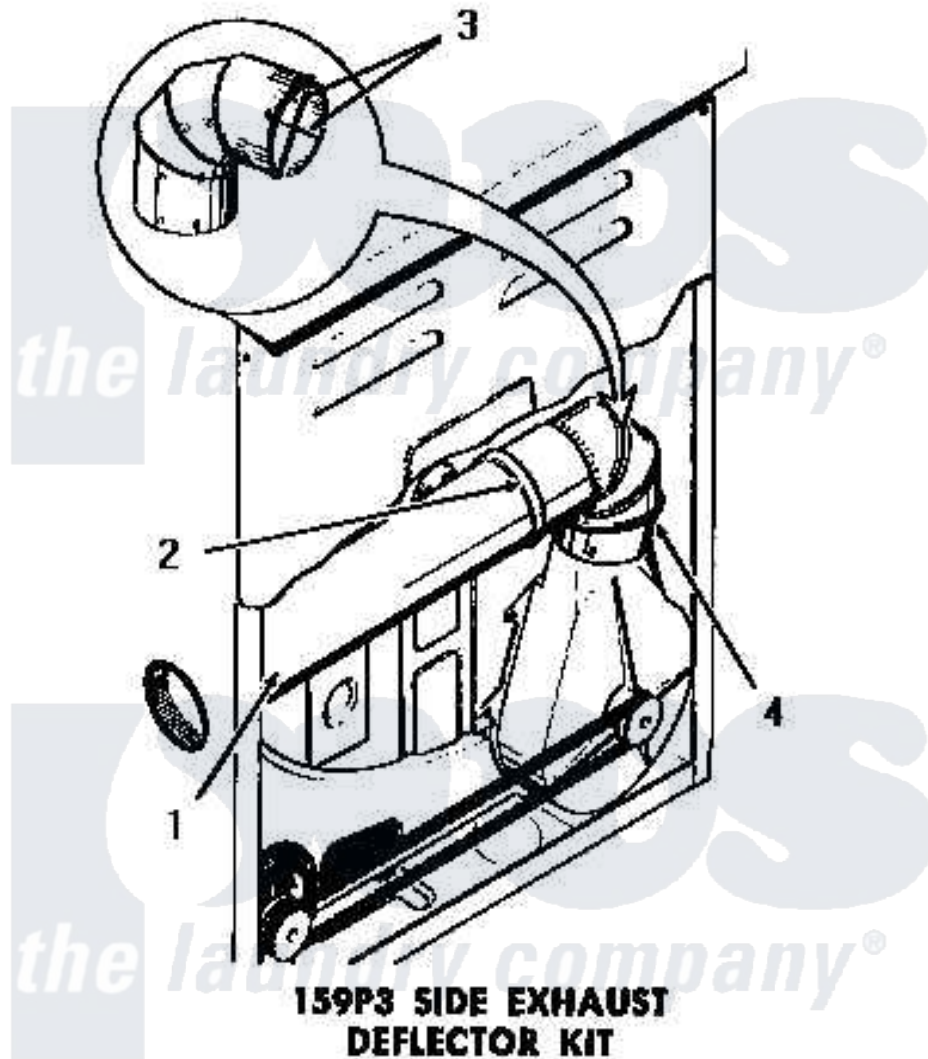

Amana [Residential Amana DG6161 Washer Parts](#) Parts Diagram 03 - 159P3 SIDE EXHAUST DEFLECTOR KIT
 Click on the part number to view part

Item	Original Part Number	Replaced By	Status	Part Description
1	Y0052776			Handle, Oven Door
2	0052775	0057344		Suptop Burner
3	Y00000000		Not Available	SEE NOTE CUT AND REMOVE WIRE GUARDS
4	Y00000000		Not Available	SEE NOTE DRYER EXHAUST ELBOW -- (SUPPLIED WITH DRYER)
NI	159P3		Not Available	SIDE EXHAUST DEFLECTOR KIT