

Amana DG6181 25 - WIRE & TERMINALS

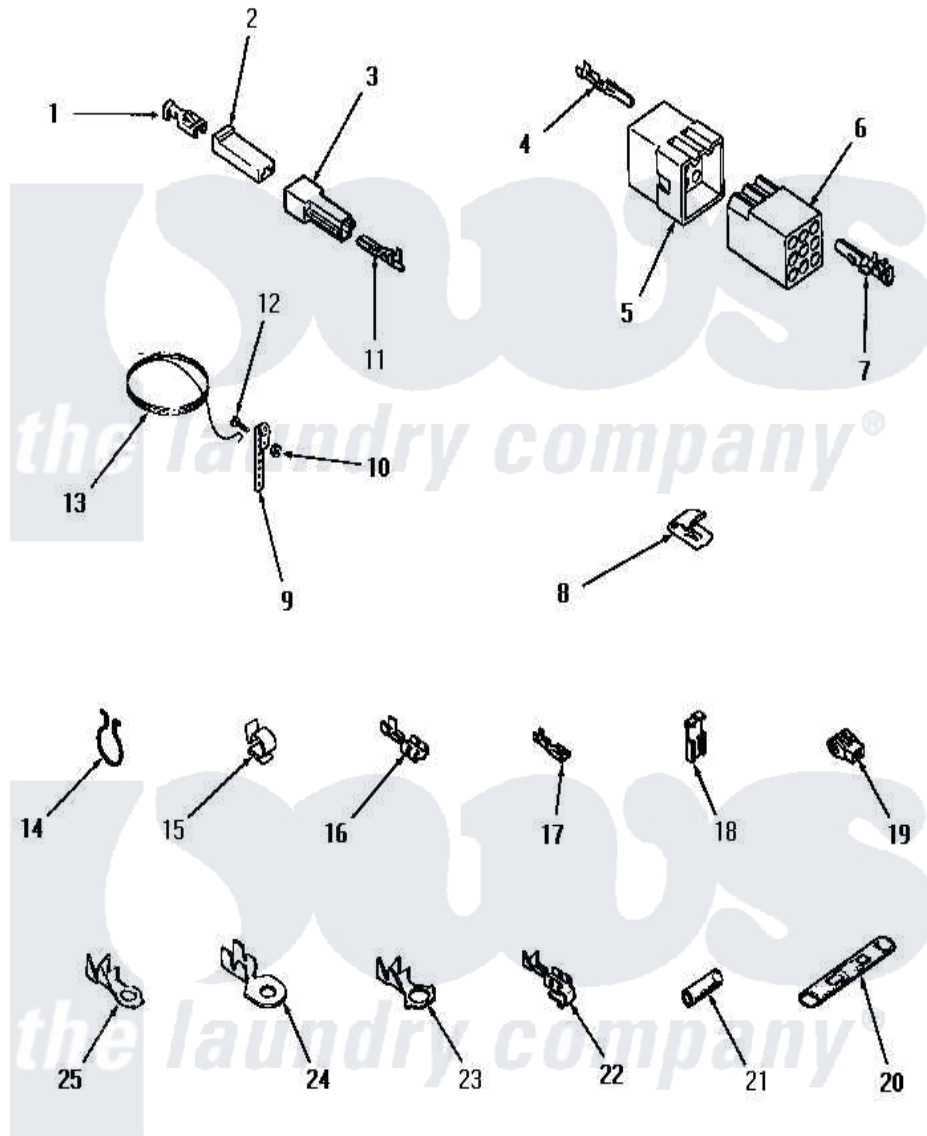

WIRE AND TERMINALS

Amana [Residential Amana DG6181 Washer Parts](#) Parts Diagram 25 - WIRE & TERMINALS
 Click on the part number to view part

Item	Original Part Number	Replaced By	Status	Part Description
1	Y00115			Lock In Spade Terminal (18 Gaug (1/4 Inch-(1) 18 Gauge Wire)
2	90789			Connector
3	90788		Not Available	HOUSING, TAB
4	Y00116			Terminal, Pin-Male
5	23033			Plug, 9 Circuit
6	26163			Receptacle, 9 Circuit
7	Y00117	5011-XX		093 Female Socket
8	20309			Cable Clip
9	21430		Not Available	STRAP, GROUND
10	Y20276		Not Available	NUT
11	00133			Terminal, Tab-1/4 Male
12	21431		Not Available	ROUND HEAD SCREW
13	Y21429		Not Available	GROUND WIRE
14	51291			Clip, Wire
15	21036			Clip, Cable

16	Y00119	Not Available	SPADE TERMINAL(18 GAUGE) (1/4 INCH-(1) 18 GAUGE WIRE)
17	00112		Terminal, Spade-3/16 Fe
18	Y00120		Terminal, Flag-1/4 Fema
19	70210	Not Available	INSULATOR,BLUE
20	21091	Not Available	CONNECTOR TWO 1/4 INCH MALE
21	Y21365	503670	Sleeve Insulator
22	Y00114		Spade Terminal
23	Y00113	Not Available	TERMINAL,RING-1/4 STUD
24	Y00111		Ring Terminal No.10 No.10 18 Gauge Wires Or
25	00110		No.10 18 Gauge Wire
NI	20680	Not Available	18 GAUGE WIRE
"	20679	Not Available	WIRE, 12 GAUGE

