

Amana DG6241 19 - MOTOR, IDLER & BELT

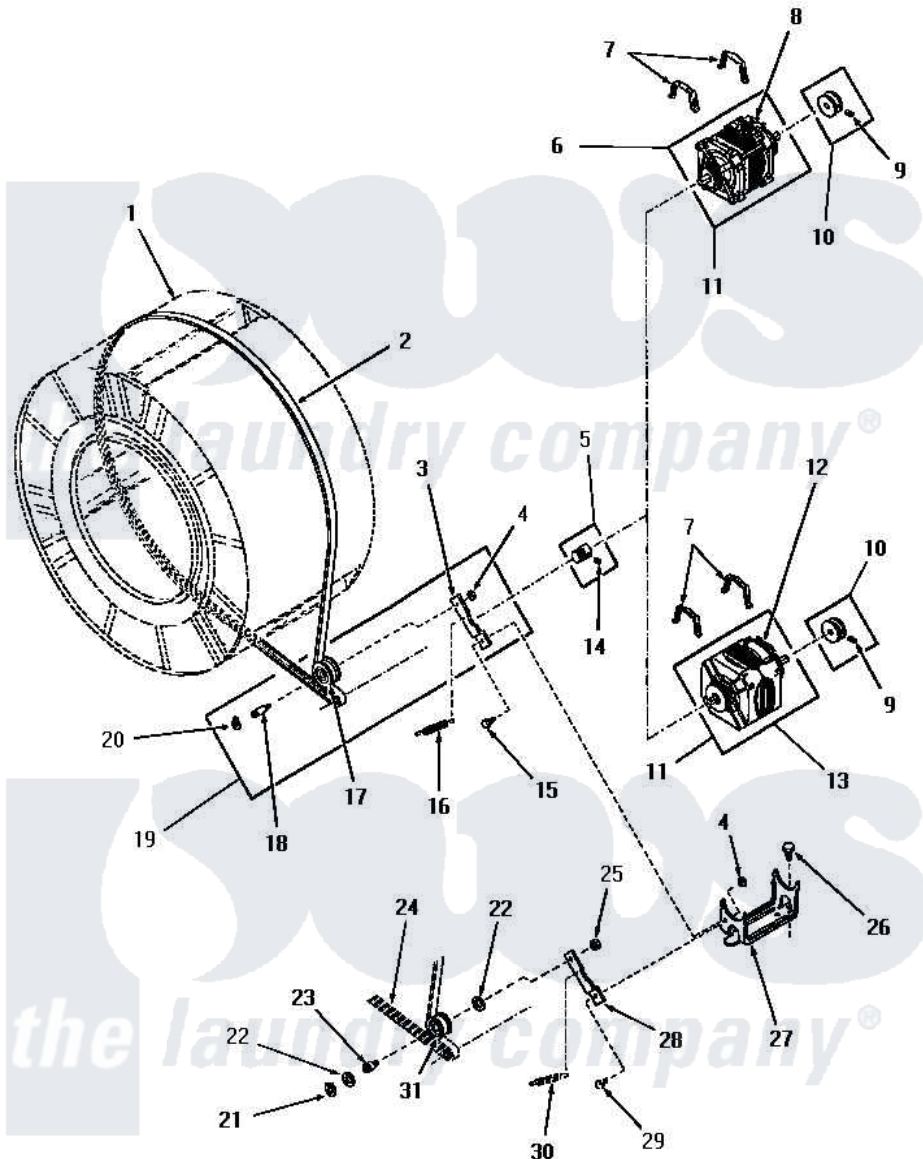

MOTOR, IDLER AND BELT

Amana [Residential Amana DG6241 Washer Parts](#) Parts Diagram 19 - MOTOR, IDLER & BELT

[Click on the part number to view part](#)

| Item | Original Part Number | Replaced By | Status | Part Description |
|------|-----------------------|--------------------------|---------------|--|
| 1 | Y00000000 | | Not Available | SEE NOTE CLOTHES DRUM |
| 2 | 52556 | | | Belt |
| 3 | 54410 | | Not Available | LEVER, IDLER |
| 4 | 52566 | 27001225 | | Nut, Jam Mid Lock 1/4-20 |
| 5 | 52593 | | Not Available | ASSY, MOTOR PULLEY |
| 6 | Y00000000 | | Not Available | SEE NOTE GENERAL ELECTRIC FORM "V" MOTOR |
| 7 | 51789 | 660658 | | Clamp, Motor Mounting 343481 685441 |
| 8 | 53249 | | Not Available | SWITCH |
| 9 | 02771 | | | Screw, 1/4-20 x 3/8 Hex S |
| 10 | 53522 | | | Pulley, Motor |
| 11 | 52697 | | Not Available | MOTOR |
| 12 | Y00000000 | | Not Available | SEE NOTE WESTINGHOUSE -- (NOT REPLACEABLE) |
| " | 53213 | | | Switch |
| " | 53226 | | Not Available | SWITCH, MOTOR |

| | | | |
|----|------------------------|---------------|--|
| " | 53214 | Not Available | MOTOR SWITCH, DELCO |
| 13 | Y00000000 | Not Available | SEE NOTE GENERAL ELECTRIC FORM "T" MOTOR |
| 14 | 52906 | Not Available | SETSCREW |
| 15 | 52567 | | Bolt, Shoulder |
| 16 | 52323 | | Spring |
| 17 | Y54414 | | Assembly, Wheel And Bearing |
| 18 | 54411 | Not Available | SHAFT, IDLER LEVER |
| 19 | 54415 | Not Available | LEVER, IDLER |
| 20 | 23748 | | Ring, Retaining |
| 21 | 70061 | | Ring, Retaining |
| 22 | Y52564 | | Washer |
| 23 | 52611 | Not Available | SHAFT, IDLER xREPLACE |
| 24 | Y00000000 | Not Available | SEE NOTE BELT |
| 25 | 52124 | Not Available | NUT |
| 26 | 23928 | Not Available | CAP SCREW AND LOCKWASHER |
| 27 | 51824 | Not Available | MOUNT, MOTOR |
| 28 | 52562 | Not Available | IDLER LEVER |
| 29 | Y00000000 | Not Available | SEE NOTE SHOULDER BOLT |
| 30 | Y00000000 | Not Available | SEE NOTE SPRING |
| 31 | 52561 | Not Available | IDLER PULLEY |

