

# Amana FA0650 19 - TRANSMISSION ASSY

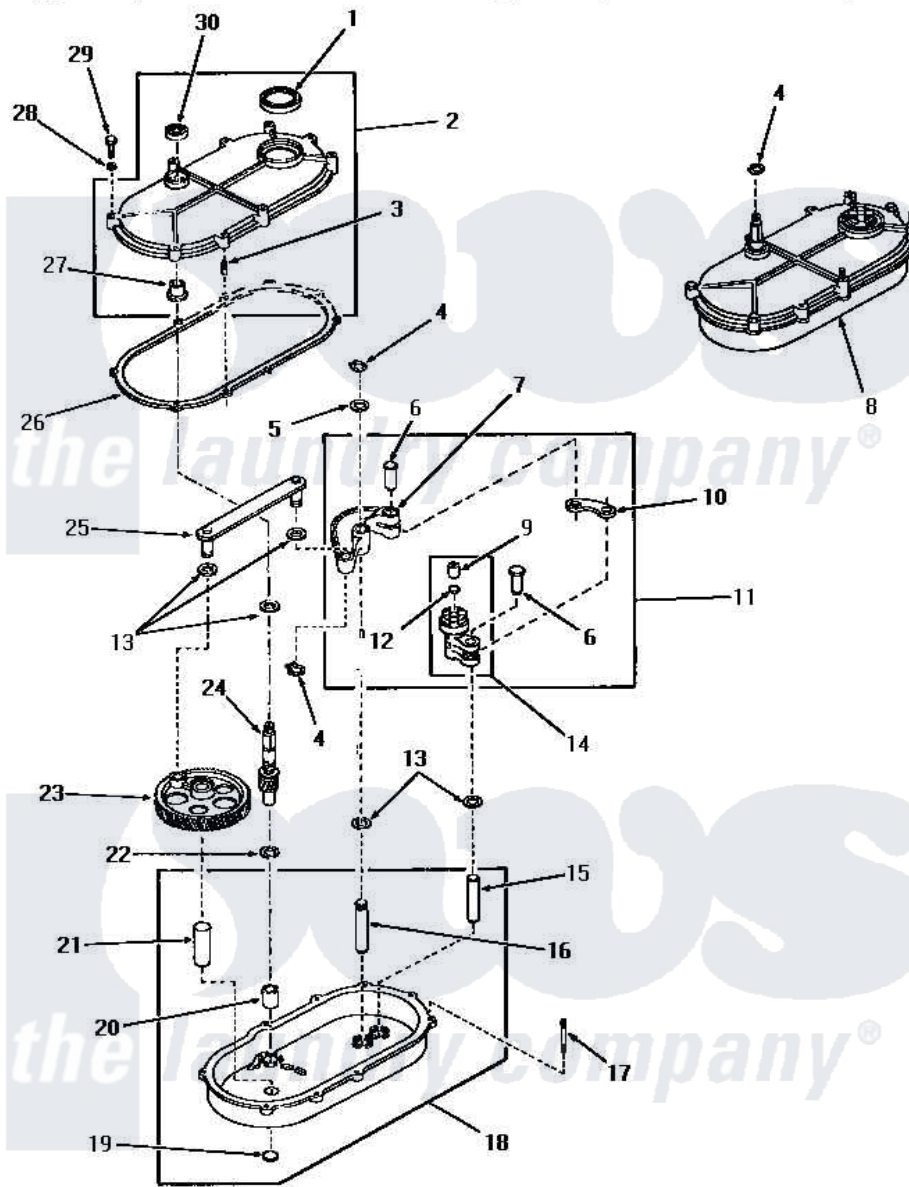

**TRANSMISSION ASSEMBLY**

Amana [Residential Amana FA0650 Washer Parts](#) Parts Diagram 19 - TRANSMISSION ASSY  
 Click on the part number to view part

Item	Original Part Number	Replaced By	Status	Part Description
1	<a href="#">20199</a>			Seal
2	20216		Not Available	ASSY,TRANSMISSION COVE
3	20197		Not Available	DOWEL PIN
4	<a href="#">23751</a>			Ring, Retaining
5	20212	<a href="#">35092</a>		Washer, 3628id X 1.00 X .056
6	<a href="#">01690</a>			Pin, Link
7	05005	<a href="#">05005P</a>		Assembly
8	<a href="#">23828</a>			Assembly, Transmission
9	01711		Not Available	BEARING
10	Y04999		Not Available	LINK
11	<a href="#">20220</a>			Assembly, Rocker Arm
12	<a href="#">Y02479</a>			Disc, Expansion
13	<a href="#">01791</a>			Washer, .626 X 1.125 X1
14	20219	<a href="#">30927P</a>		Assembly Clutch Arm
15	01688		Not Available	PIN
16	24817		Not Available	PIN,ROCKER ARM

17	20155		Not Available	STUD,DOUBLE END 1/4-20
18	23927		Not Available	ASSY,TRANSMISSION xREPLACE
19	<a href="#">Y02769</a>			Disc
20	<a href="#">01993</a>			Bearing, 7/8odx5/8id
21	03477		Not Available	PIN
22	20198	<a href="#">41813</a>		Csa 20198 20 4w 19 Deg Cc
23	02175		Not Available	GEAR,CRANK
24	<a href="#">23645</a>			Pinion
25	03969	<a href="#">03969P</a>		Rod Connecting
26	<a href="#">20059</a>			Gasket
27	<a href="#">20082</a>			Bearing
28	<a href="#">03189</a>			LoCkwasher, 1/4 Std-C P
29	20257		Not Available	SCREW,1/4-20 X 1-1/4 H
30	<a href="#">20200</a>			Seal
NI	02528	<a href="#">02528P</a>		Grease Transmission Mobil 209

