

Amana FA3201 20 - PANELS

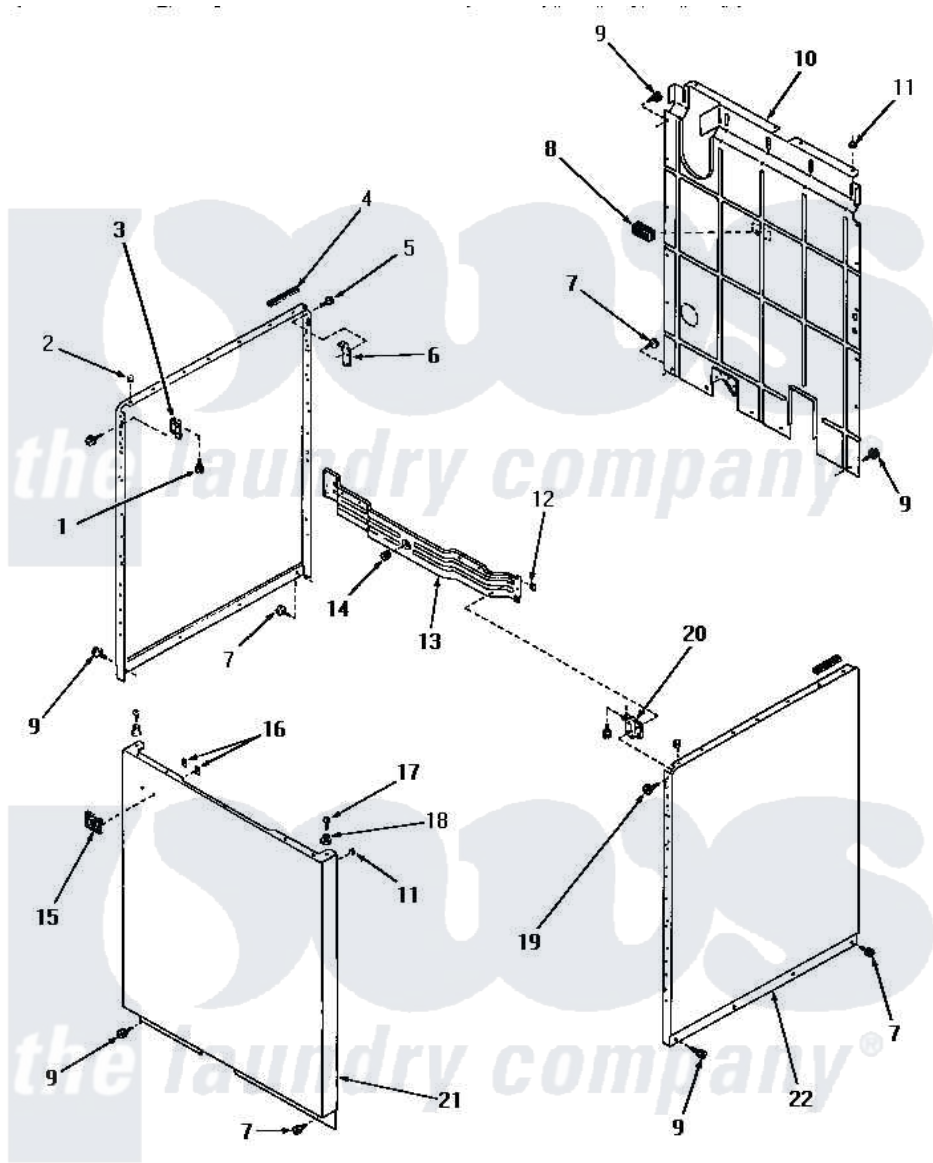

PANELS

Amana [Residential Amana FA3201 Washer Parts](#) Parts Diagram 20 - PANELS
 Click on the part number to view part

Item	Original Part Number	Replaced By	Status	Part Description
1	23008			Screw, 10-24 X 3/4 Sems
2	21176			Bumper
3	22847		Not Available	BRACKET
"	26691		Not Available	BRACKET,HOLD DOWN-L.H.
4	80312			Bumper Pad
5	51784		Not Available	SCREW,10B-16 X 1/2 HEX
6	52487			Lug, Hold-Down
7	26415	27001200		Screw
8	23257		Not Available	PAD,BUMPER
9	26592		Not Available	HEX HEAD SCREW
10	24342GR		Not Available	REAR PANEL, GRAY
11	20387			Bumper
12	25987		Not Available	NUT,SPEED
"	21747			Nut, Speed
13	21262		Not Available	CROSS BRACE, FRONT
14	25959			Grommet

15	22086	Not Available	MONOGRAM
16	22161	Not Available	CLIP
17	Q6535	Not Available	SCREW,10B-16 X 3/4 ROU
18	23020	Not Available	MOUNT,PANEL
19	03814		Screw, 10-24 X 1/2 Roun
"	51784	Not Available	SCREW,10B-16 X 1/2 HEX
20	22846	Not Available	BRACKET
"	26690	Not Available	BRACKET,HOLD DOWN-R.H.
21	24687A	Not Available	FRONT PANEL, AVOCADO
"	24687W	Not Available	FRONT PANEL, WHITE
"	24687H	Not Available	FRONT PANEL, HARVEST GOLD
"	24687C	Not Available	FRONT PANEL, COPPERTONE
22	24336A	Not Available	SIDE PANEL, RIGHT OR LEFT, AVO
"	24336W	Not Available	xREPLACE
"	24336H	Not Available	SIDE PANEL, RIGHT OR LEFT, HAR
"	24336C	Not Available	SIDE PANEL, RIGHT OR LEFT, COP

