

Amana FA3820 08 - CBAL WEIGHT, BRKT, MTG PLT & TRANS

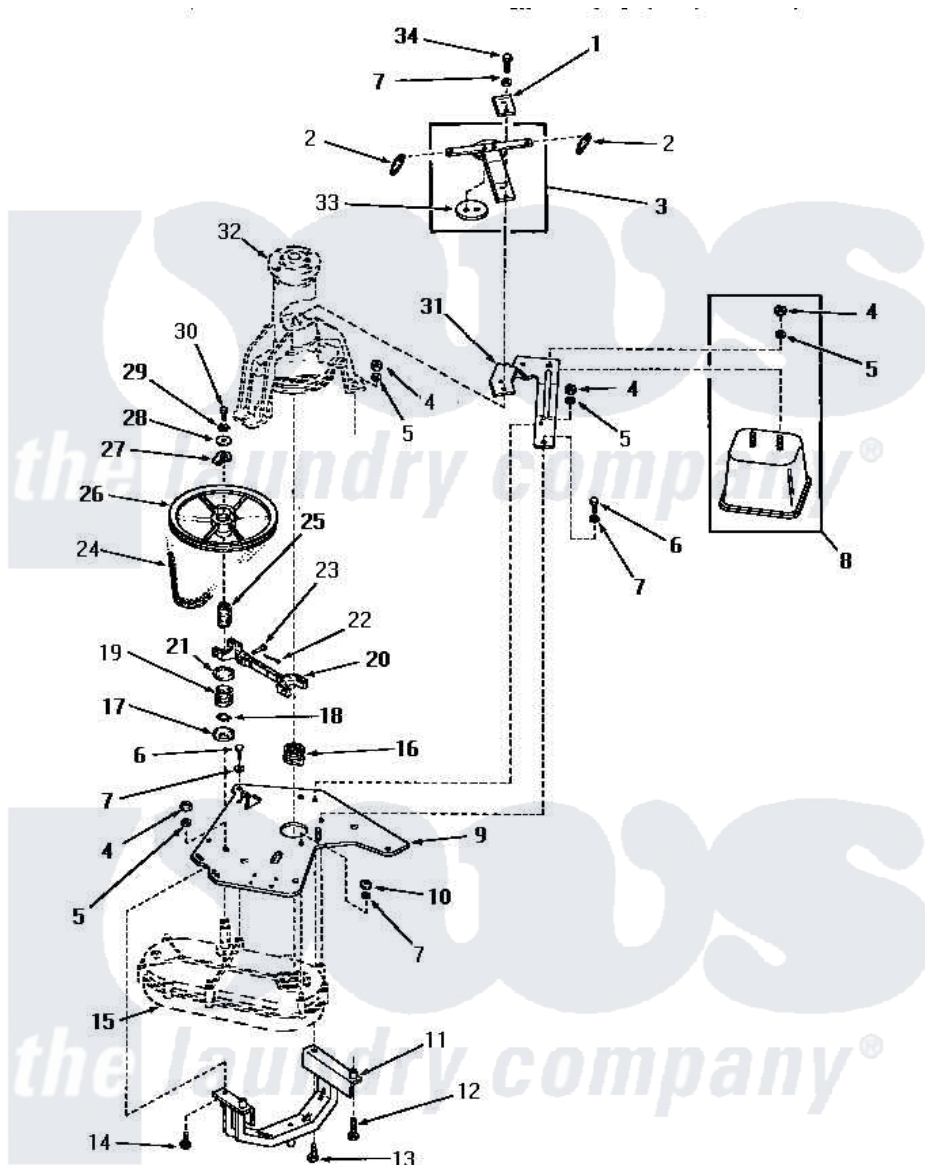

**COUNTERBALANCE WEIGHT, BRACKET,
MOUNTING PLATE AND TRANSMISSION BELT**

Amana [Residential Amana FA3820 Washer Parts](#) Parts Diagram 08 - CBAL WEIGHT, BRKT, MTG PLT & TRANS
Click on the part number to view part

Item	Original Part Number	Replaced By	Status	Part Description
1	22614			Plate, Support
2	23632			Spring
3	20168			Assembly, Snubber
4	20274	62739		Nut, Lock
5	20277			Lockwasher, 3/8 Std X 3
6	20264			Screw, 1/4-20 X 2 HeX H
7	03189			LoCkwasher, 1/4 Std-C P
8	25230		Not Available	COUNTERBALANCE WEIGHT
9	24749		Not Available	MOUNTING PLATE
10	20275	27001225		Nut, Jam Mid Lock 1/4-20
11	22702		Not Available	ASSY,YOKE & SLEEVE
12	Y22688		Not Available	SCREW,CAP-3/8-16X1-1/4
13	20255		Not Available	SCREW,3/8-16 X 1 HEX H
14	22687		Not Available	SCREW
15	Y00000000		Not Available	SEE NOTE TRANSMISSION ASSEMBLY
16	23647			Jaw

17	26611	Not Available	RETAINER,SPRING-LOWER
18	23751		Ring, Retaining
19	26609		Spring
20	23732		Assembly, Shifter Fork
21	26610		Retainer, Spring-Upper
22	20248		Pin, Cotter
23	23718	Not Available	PIN,SHIFTER
24	23758		Belt
25	23644		Hub
26	23773	Not Available	ASSY,PULLEY-TRANSMISSI
27	23643		Pulley Stop
28	23716	Not Available	WASHER
29	Y03421	Not Available	LOCKWASHER
30	02422		Screw, 1/4-20 X 1/2 HeX
31	25139	Not Available	BRACKET
32	Y00000000	Not Available	SEE NOTE MAIN BEARING
33	20453	Not Available	DISC,FRICITION
34	24233	Not Available	SCREW,CAP-1/4-20 X 3/4
NI	03200		A-D Drive Lubricant
"	285P3	23911	Kit Spring

