

Amana FA6300 03 - AGITATOR POST & SPIN TUB

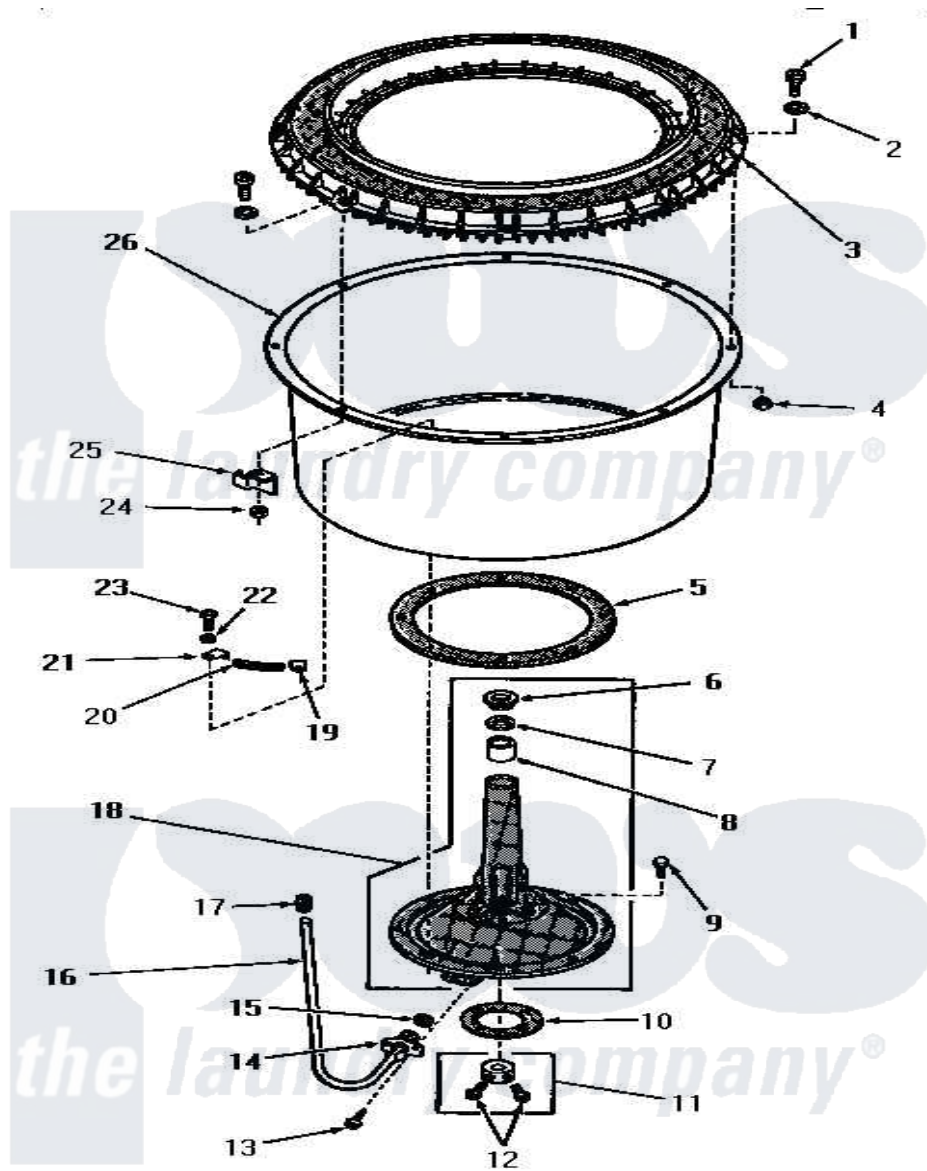

AGITATOR POST AND SPIN TUB

Amana [Residential Amana FA6300 Washer Parts](#) Parts Diagram 03 - AGITATOR POST & SPIN TUB
 Click on the part number to view part

Item	Original Part Number	Replaced By	Status	Part Description
1	25251	EZ25251		25 x 25 x 1 Filter 1 Metal Side
2	25100			Washer, 17/64 ID x 1/2 OD
3	24931		Not Available	BALANCE RING
4	25250			Nut, 1/4-20 Hex Nyllock
5	20122			Gasket
6	23685			Bearing
7	23684			Seal
8	23686			Bearing
9	20261			Screw, Cap
10	20120			Gasket
11	20377			Collar Assembly
12	23481	02422		Screw, 1/4-20 X 1/2 HeX
13	20852		Not Available	SCREW, 10-24 X 1/2 HEX
14	26046			Bracket, Sediment Tube
15	20110			Gasket
16	25980			Tube, Sediment

17	22361		Sleeve
18	26016	2-6016	Wheel 71/2x6
19	22446		Clip
20	22144		Spring
21	22447		Clip
22	20121	Not Available	GASKET
23	20260		Screw, 5/16-18 X 3/4 RD
24	26678		Nut, Self-Locking
25	22025		Bracket
26	26910		Tub, Spin-Blue Porcelain
NI	243P3	Not Available	KIT,AGITATOR POST

