

Amana FE4231 10 - PANELS

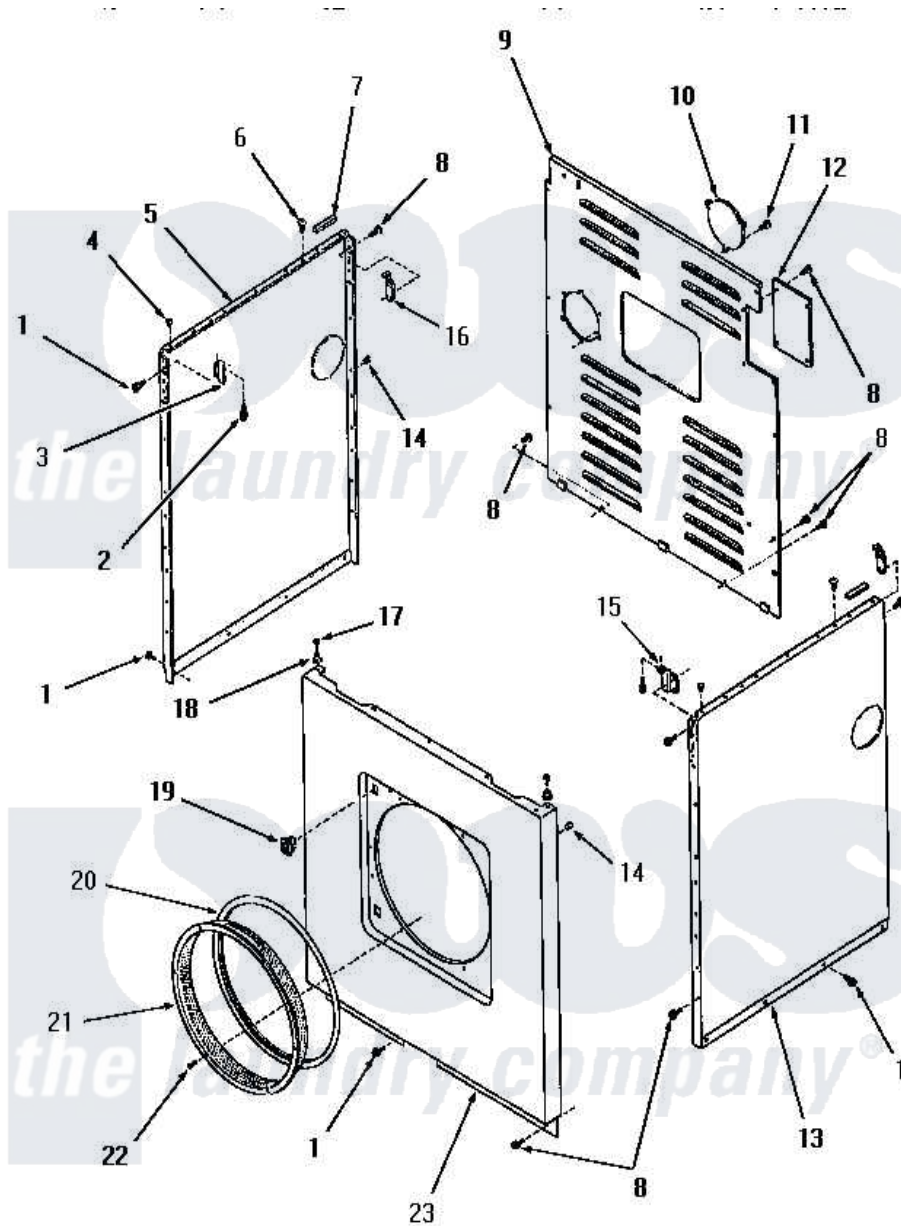

Amana [Residential Amana FE4231 Washer Parts](#) Parts Diagram 10 - PANELS
 Click on the part number to view part

Item	Original Part Number	Replaced By	Status	Part Description
1	51784		Not Available	SCREW,10B-16 X 1/2 HEX
2	23008			Screw, 10-24 X 3/4 Sems
3	22847		Not Available	BRACKET
4	21176			Bumper
5	55907W		Not Available	SIDE PANEL, RIGHT, WHITE
"	55907C		Not Available	SIDE PANEL, LEFT, COPPERTONE
"	55907H		Not Available	SIDE PANEL, LEFT, HARVEST GOLD
"	55907A		Not Available	SIDE PANEL, LEFT, AVOCADO
6	52442		Not Available	SCREW, No.10-16 X 3/8"
7	80312			Bumper Pad
8	25723	27001200		Screw
9	52677GR		Not Available	PANEL,REAR xREPLACE
10	51855GR			Plate, Cover
11	51782		Not Available	SCREW, 6B-20X5/16

12	52108GR	Not Available	TERMINAL BLOCK ACCESS PLATE, G
13	55908H	Not Available	SIDE PANEL, RIGHT, HARVEST GOL
"	55908W	Not Available	SIDE PANEL, RIGHT, WHITE
"	55908C	Not Available	SIDE PANEL, RIGHT, COPPERTONE
"	55908A	Not Available	SIDE PANEL, RIGHT, AVOCADO
14	20387		Bumper
15	22846	Not Available	BRACKET
16	52487		Lug, Hold-Down
17	Q6535	Not Available	SCREW, 10B-16 X 3/4 ROU
18	23020	Not Available	MOUNT, PANEL
19	54660	LA-1003	Door Catch Kit
20	51799		Seal, Outer
21	52052GR	Not Available	DUCT RING, GRAY
22	51778		Screw, 8b-18 X 1/2 RD H
23	55901W	Not Available	FRONT PANEL, WHITE
"	55901A	Not Available	FRONT PANEL, AVOCADO
"	55901H	Not Available	PANEL, FRONT
"	55901C	Not Available	FRONT PANEL, COPPERTONE

