

Amana FE9021 13 - REAR FRAME AND FRAME BASE

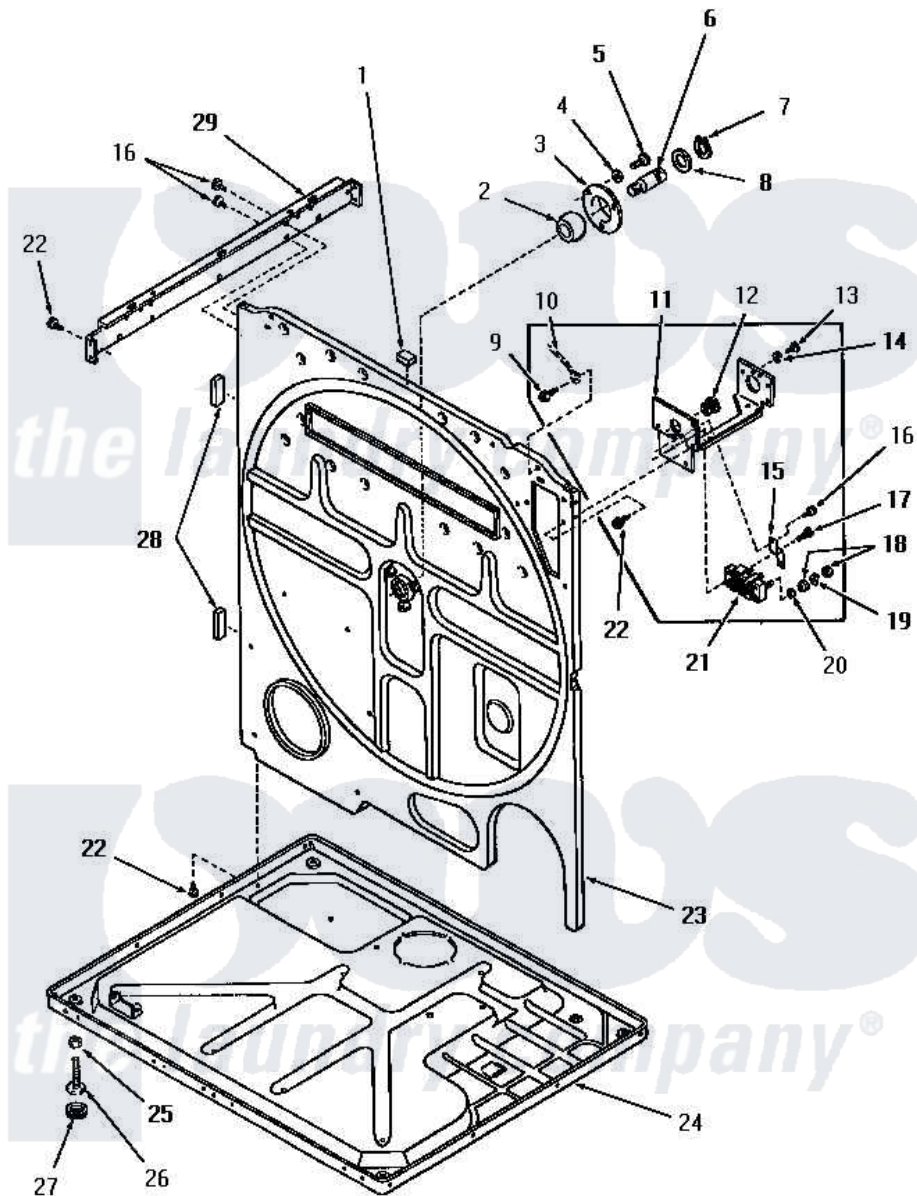

Amana Residential Amana FE9021 Washer Parts Parts Diagram 13 - REAR FRAME AND FRAME BASE
 Click on the part number to view part

Item	Original Part Number	Replaced By	Status	Part Description
1	54024		Not Available	BUMPER
2	Y52079			Bearing, Drum Shaft
3	51826		Not Available	COVER,BEARING
4	03189			LoCkwasher, 1/4 Std-C P
5	53589	8204624		Bolt
6	53132		Not Available	SHAFT,DRUM
7	70061			Ring, Retaining
8	Y52564			Washer
9	51784		Not Available	SCREW,10B-16 X 1/2 HEX
10	Y00000000		Not Available	SEE NOTE GROUND WIRE, GREEN
11	Y52110		Not Available	TERMINAL BLOCK BRACKET
12	52113			Relief, Strain
13	52909			Screw, 10B-16 X 1/2 HeX
14	51474		Not Available	WASHER,13/64IDX1/2ODX.
15	53950		Not Available	STRAP,GROUND
16	51780	3390631		Screw, 10-16 X 3/8

17	Q6535		Not Available	SCREW, 10B-16 X 3/4 ROU
18	Q6163		Not Available	NUT
19	51474		Not Available	WASHER, 13/64IDX1/2ODX.
20	Q6623		Not Available	WASHER
21	50854	33001244		Block, Terminal
22	25723	27001200		Screw
23	52574		Not Available	FRAME, REAR
24	Y52572		Not Available	FRAME BASE
25	52794	62739		Nut, Lock
26	Y52696	Y305086		Adjustable Leg And Nut
27	70282	Y314137		Foot, Rubber
28	20354		Not Available	BUMPER PAD
29	51818		Not Available	SUPPORT CHANNEL, RIGHT OR LEFT

