

Amana FG6291 12 - PANELS

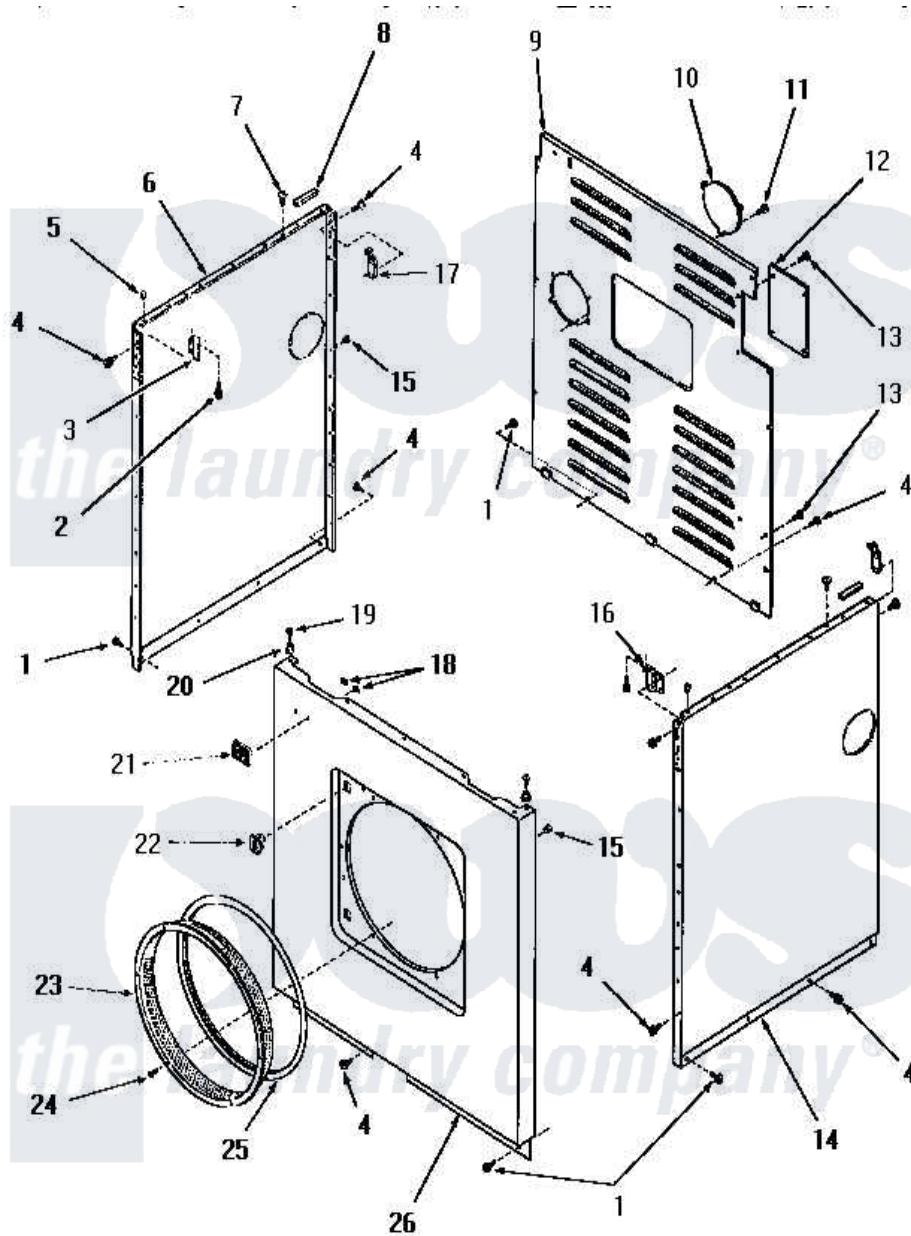

Amana [Residential Amana FG6291 Dryer Parts](#) Parts Diagram 12 - PANELS
 Click on the part number to view part

Item	Original Part Number	Replaced By	Status	Part Description
1	25723	27001200		Screw
2	23008			Screw, 10-24 X 3/4 Sems
3	22847		Not Available	BRACKET
4	51784		Not Available	SCREW,10B-16 X 1/2 HEX
5	21176			Bumper
6	52669H		Not Available	SIDE PANEL, LEFT, HARVEST GOLD
"	52669C		Not Available	SIDE PANEL, LEFT, COPPERTONE
"	52669A		Not Available	SIDE PANEL, LEFT, AVOCADO
"	52669W		Not Available	SIDE PANEL, LEFT, WHITE
7	52442		Not Available	SCREW, No.10-16 X 3/8"
8	80312			Bumper Pad
9	52677GR		Not Available	PANEL,REAR xREPLACE
10	51855GR			Plate, Cover
11	51782		Not Available	SCREW, 6B-20X5/16

12	52108GR		Not Available	TERMINAL BLOCK ACCESS PLATE, G
13	51780	3390631		Screw, 10-16 X 3/8
14	52673A		Not Available	SIDE PANEL, RIGHT, AVOCADO
"	52673H		Not Available	SIDE PANEL, RIGHT, HARVEST GOL
"	52673C		Not Available	SIDE PANEL, RIGHT, COPPERTONE
"	52673W		Not Available	SIDE PANEL, RIGHT, WHITE
15	20387			Bumper
16	22846		Not Available	BRACKET
17	52487			Lug, Hold-Down
18	22161		Not Available	CLIP
19	Q6535		Not Available	SCREW, 10B-16 X 3/4 ROU
20	23020		Not Available	MOUNT, PANEL
21	22086		Not Available	MONOGRAM
22	54660	LA-1003		Door Catch Kit
23	52052GR		Not Available	DUCT RING, GRAY
24	51778			Screw, 8b-18 X 1/2 RD H
25	51799			Seal, Outer
26	54664C		Not Available	FRONT PANEL, COPPERTONE
"	54664W		Not Available	FRONT PANEL, W
"	54664A		Not Available	FRONT PANEL, AVOCADO
"	54664H		Not Available	FRONT PANEL, HARVEST GOLD

the laundry company®

the laundry company®