

Amana HA2410 09 - INLET/FILL HOSE/BACK FL PREVENTER & BRKT

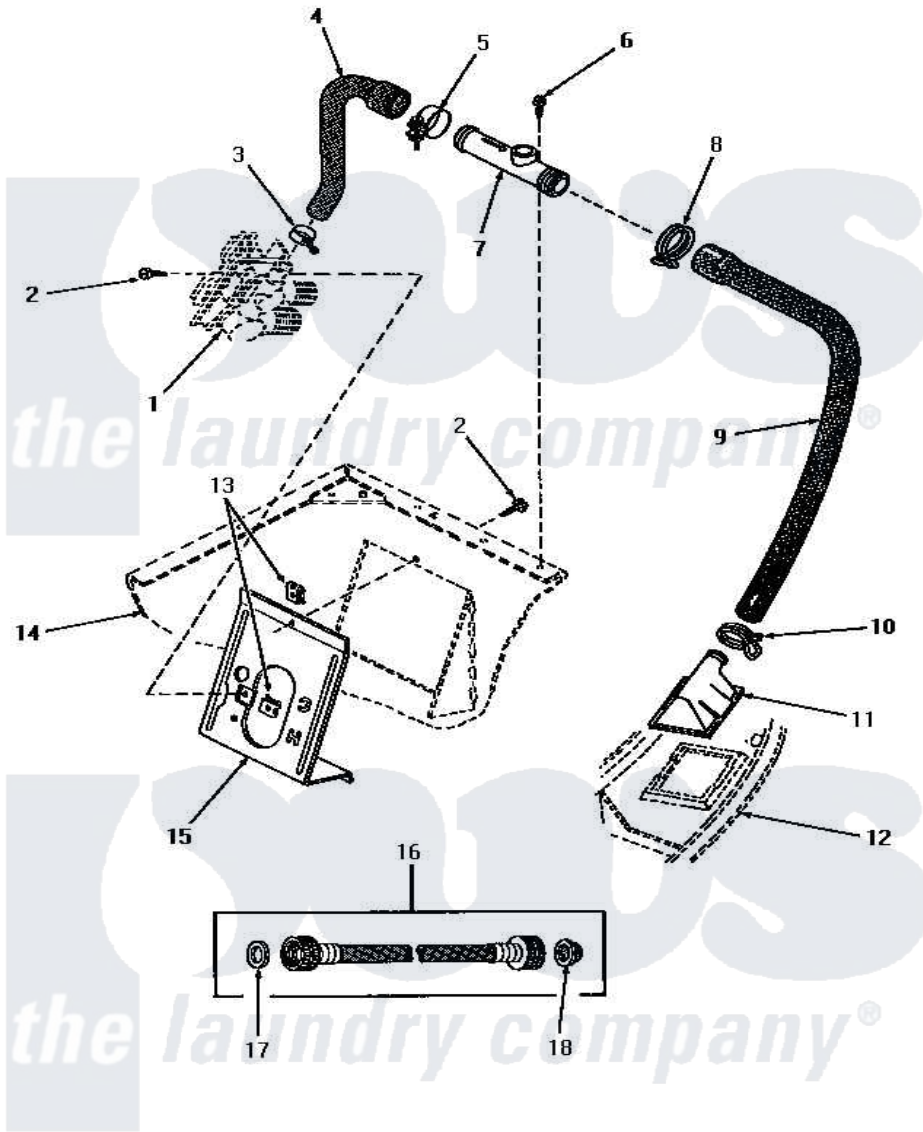

**INLET HOSE, FILLER HOSE, BACK FLOW PREVENTER
AND MIXING VALVE MOUNTING BRACKET
(starting with Serial No. N3805085)**

Amana [Residential Amana HA2410 Washer Parts](#) Parts Diagram 09 - INLET/FILL HOSE/BACK FL PREVENTER & BRKT

[Click on the part number to view part](#)

Item	Original Part Number	Replaced By	Status	Part Description
1	Y00000000		Not Available	SEE NOTE MIXING VALVE
2	56392		Not Available	SCREW,8-18 X 3/8 TAPPI
3	27643	596669		Clamp, Manifold
4	27183			Hose, Mixing Valve
5	27152		Not Available	CLAMP HOSE
6	23962	W10116760		Screw
7	27118	34280		Assembly, Backflow Prevento
8	29176	285655		Clamp, Hose
9	29182		Not Available	HOSE,WATER INLET
10	29210			Hose Clamp
11	29154			Head, Water Inlet
12	Y00000000		Not Available	SEE NOTE OUTER TUB COVER
13	54038			NUt, Speed U-Type
14	Y00000000		Not Available	SEE NOTE CABINET
15	27126	39407		Bracket, Valve

16	28330	202860	Inlet Hose Assembly
17	20290	Y013783	Washer, Inlet Hose
18	28605	22002960	Strainer, Washer Inlet

