

Amana HA4001 04 - BRG HSG/BRAKE/PULLEY & PIVOT DOME

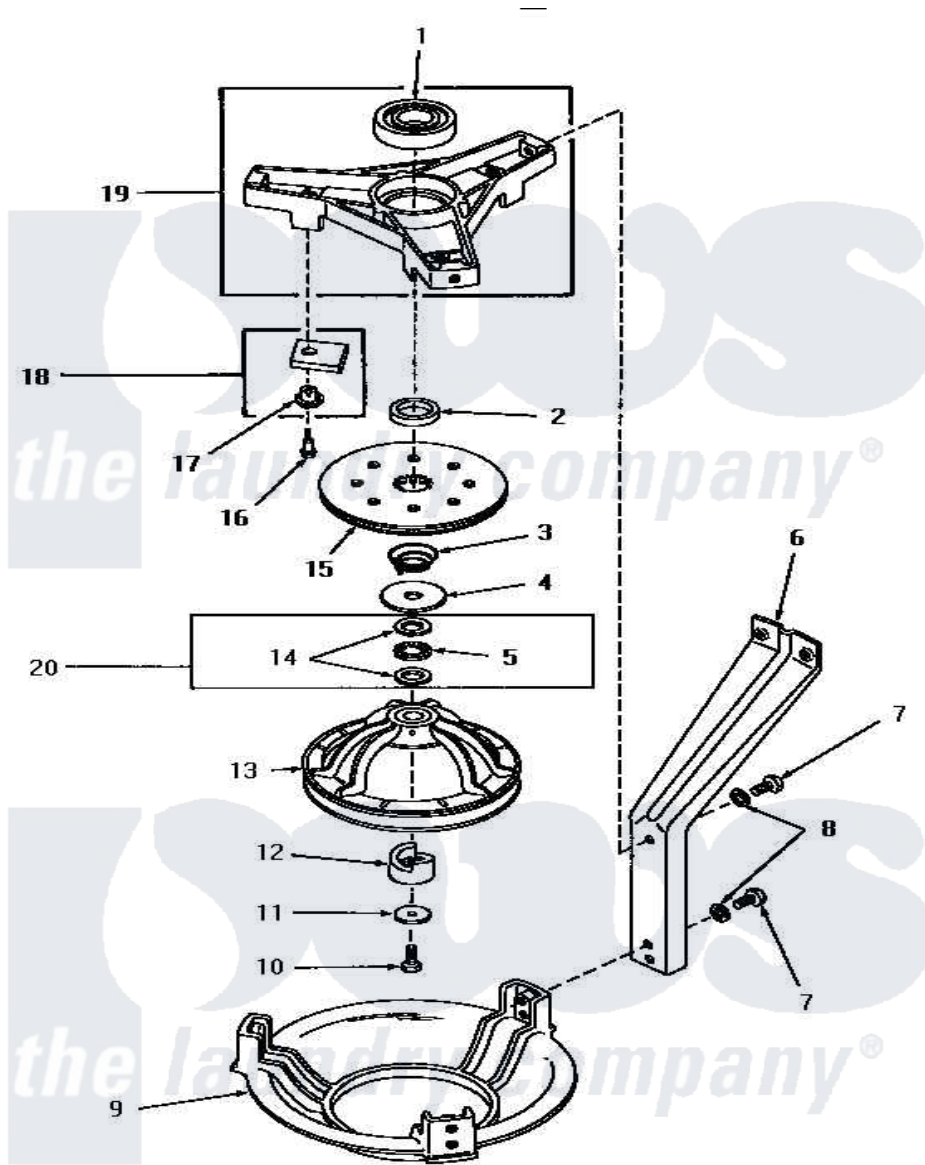

BEARING HOUSING, BRAKE, PULLEY AND PIVOT DOME

Amana [Residential Amana HA4001 Washer Parts](#) Parts Diagram 04 - BRG HSG/BRAKE/PULLEY & PIVOT DOME
 Click on the part number to view part

Item	Original Part Number	Replaced By	Status	Part Description
1	28944	40004001		Bearing, Main
2	27176			Spacer
3	27014	33435		Spring, Conical
4	27015	40063201		Washer, Flat
5	27025		Not Available	BEARING,NEEDLE THRUST
6	27090			Leg, Support
7	30016	40128701		Screw, 5/16-18 X .50
8	04366			Lockwasher, 5/16intshkp
9	27124		Not Available	DOME,PIVOT
10	27220	40063401		Screw, 1/4-20 x 5/8 Hex
11	26509	40041501		Washer
12	27018			Helix
13	30260	34232P		Kit-Pulley
"	27111	34232P		Kit-Pulley
14	27024		Not Available	NO LONGER AVAILABLE
15	26556	R9900474		Brake Assembly

16	26547		Screw, 10-24 Shoulder
17	29993		Sleeve, Anti-Rotation
18	348P3	R9900543	Pad-Brake
19	28913	35746	AssembLy, Bearing Housing-L
20	Y0000000	Not Available	SEE NOTE BEARING RACE AND NEEDLE BEARING -- (USED THROUGH SERIAL NO.4U029469)

