

Amana HA4001 08 - INLET/FILL HOSE/BACK FL PREVENTER & BRKT

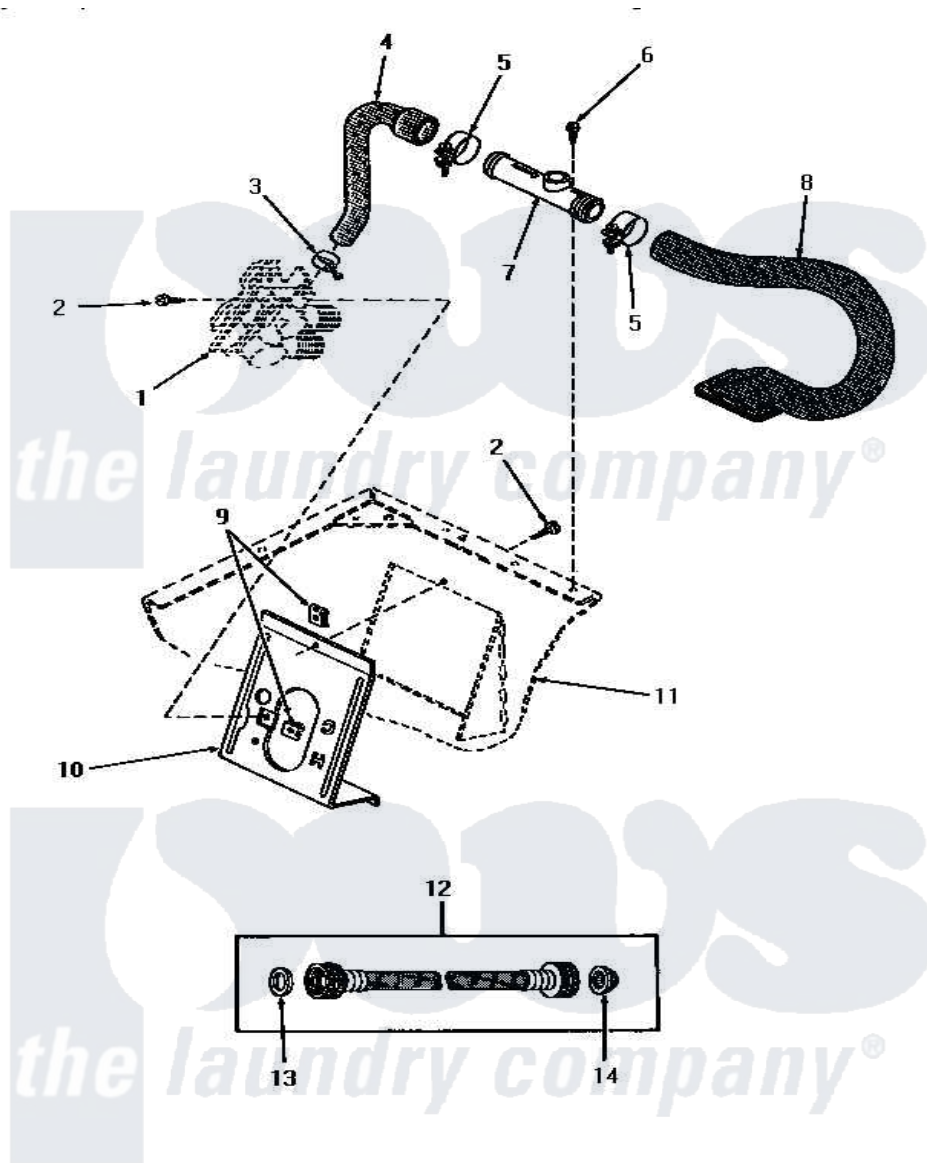

**INLET HOSE, FILLER HOSE, BACK FLOW PREVENTER
AND MIXING VALVE MOUNTING BRACKET
(through Serial No. N3805084)**

Amana [Residential Amana HA4001 Washer Parts](#) Parts Diagram 08 - INLET/FILL HOSE/BACK FL PREVENTER & BRKT

[Click on the part number to view part](#)

Item	Original Part Number	Replaced By	Status	Part Description
1	Y00000000		Not Available	SEE NOTE MIXING VALVE
2	56392		Not Available	SCREW,8-18 X 3/8 TAPPI
3	27643	596669		Clamp, Manifold
4	27183			Hose, Mixing Valve
5	27152		Not Available	CLAMP HOSE
6	23962	W10116760		Screw
7	27118	34280		Assembly, Backflow Prevento
8	27231		Not Available	HOSE
9	54038			NUT, Speed U-Type
10	27126	39407		Bracket, Valve
11	Y00000000		Not Available	SEE NOTE CABINET
12	28330	202860		Inlet Hose Assembly
13	20290	Y013783		Washer, Inlet Hose
14	28605	22002960		Strainer, Washer Inlet