

# Amana HA4370 09 - INLET/FILL HOSE/BACK FL PREVENTER & BRKT

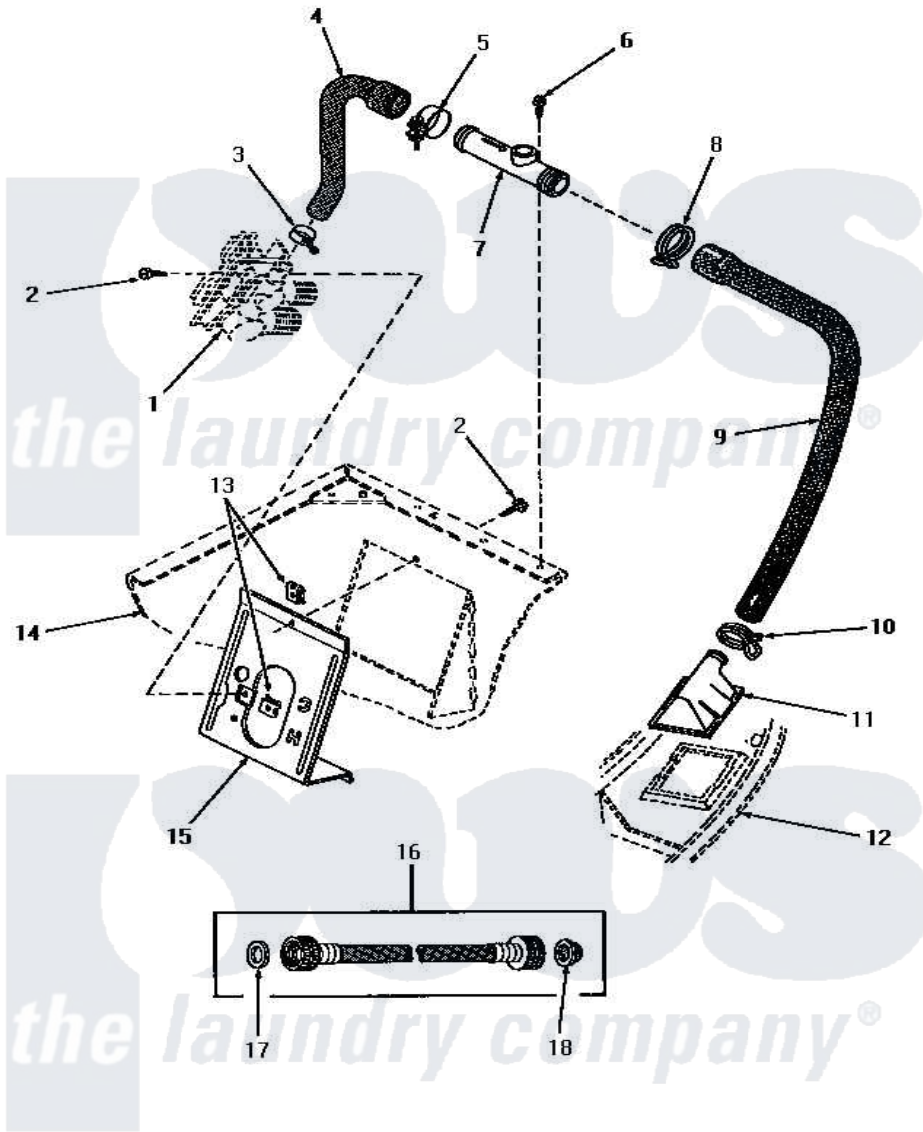

**INLET HOSE, FILLER HOSE, BACK FLOW PREVENTER  
AND MIXING VALVE MOUNTING BRACKET  
(starting with Serial No. N3805085)**

Amana [Residential Amana HA4370 Washer Parts](#) Parts Diagram 09 - INLET/FILL HOSE/BACK FL PREVENTER & BRKT

[Click on the part number to view part](#)

Item	Original Part Number	Replaced By	Status	Part Description
1	Y00000000		Not Available	SEE NOTE MIXING VALVE
2	56392		Not Available	SCREW,8-18 X 3/8 TAPPI
3	27643	<a href="#">596669</a>		Clamp, Manifold
4	<a href="#">27183</a>			Hose, Mixing Valve
5	27152		Not Available	CLAMP HOSE
6	23962	<a href="#">W10116760</a>		Screw
7	27118	<a href="#">34280</a>		Assembly, Backflow Prevento
8	29176	<a href="#">285655</a>		Clamp, Hose
9	29182		Not Available	HOSE,WATER INLET
10	<a href="#">29210</a>			Hose Clamp
11	<a href="#">29154</a>			Head, Water Inlet
12	Y00000000		Not Available	SEE NOTE OUTER TUB COVER
13	<a href="#">54038</a>			NUt, Speed U-Type
14	Y00000000		Not Available	SEE NOTE CABINET
15	27126	<a href="#">39407</a>		Bracket, Valve

16	28330	<a href="#">202860</a>	Inlet Hose Assembly
17	20290	<a href="#">Y013783</a>	Washer, Inlet Hose
18	28605	<a href="#">22002960</a>	Strainer, Washer Inlet

