

# Amana HA4520 20 - SHORT POST DRIVE (ADDITION)

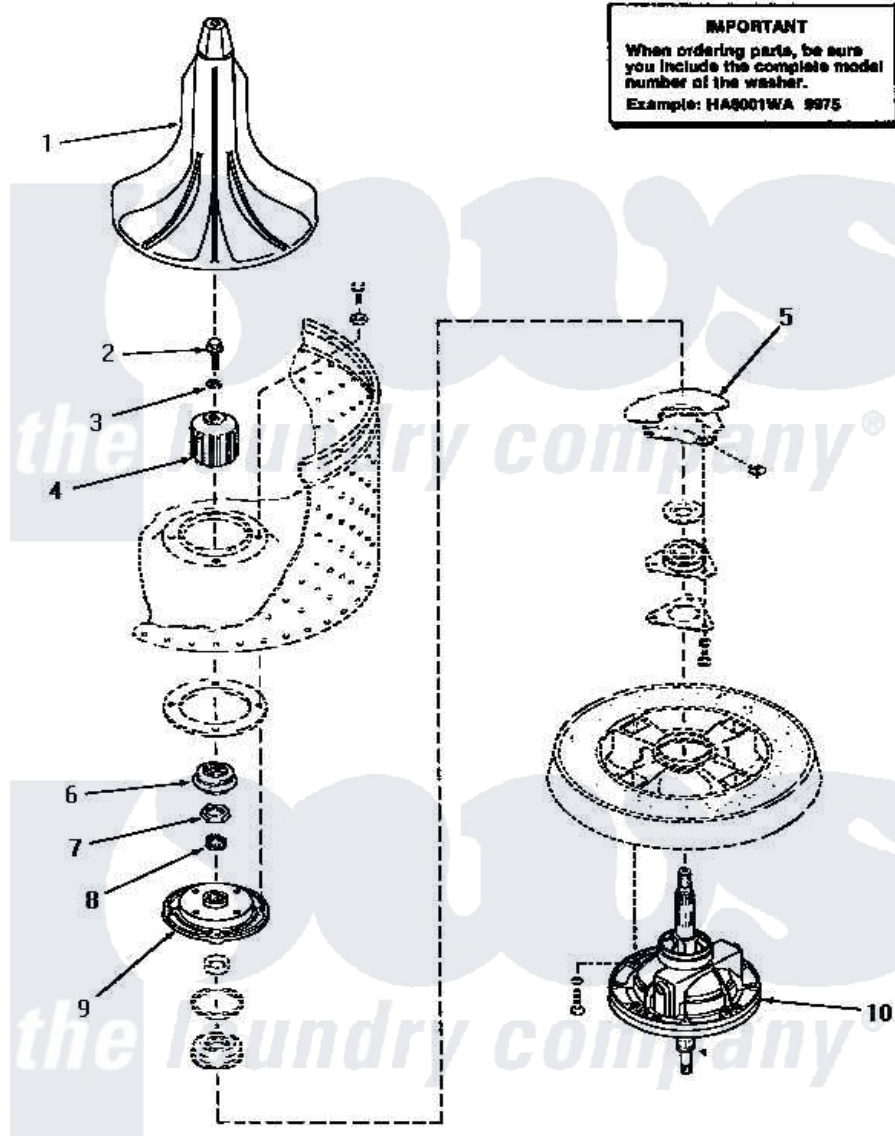

## SHORT POST DRIVE

Amana [Residential Amana HA4520 Washer Parts](#) Parts Diagram 20 - SHORT POST DRIVE (ADDITION)  
 Click on the part number to view part

Item	Original Part Number	Replaced By	Status	Part Description
1	30855	<a href="#">40000501W</a>		Agitator, Flex Vane
2	<a href="#">30852</a>			Screw, No.8-1/4 X 20 X 3/
3	30853		Not Available	SEAL
4	30071	<a href="#">R9900189</a>		Kit, Drive Bell And Seal
5	Y00000000		Not Available	SEE NOTE OUTER TUB
6	30022		Not Available	ASSY,SEAL-HEAD xREPLACE
7	Y29220	<a href="#">40016301</a>		Nut, Lock
8	29728	<a href="#">40008301</a>		Insert, Spline
9	30034		Not Available	HUB ASSEMBLY
10	30848	<a href="#">33227P</a>		Assembly- Tran
"	33227	<a href="#">33227P</a>		Assembly- Tran