

# Amana HA6000 08 - INLET/FILL HOSE/BACK FL PREVENTER & BRKT

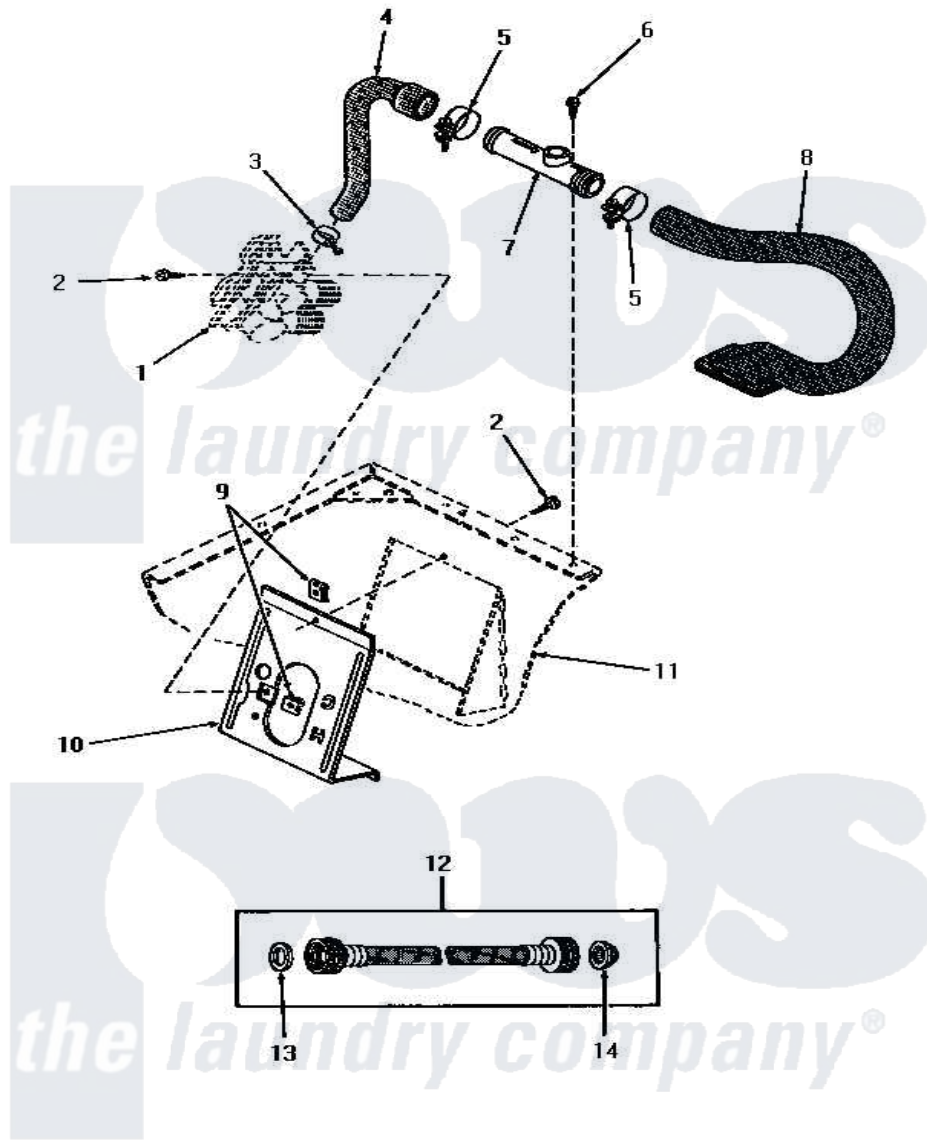

**INLET HOSE, FILLER HOSE, BACK FLOW PREVENTER  
AND MIXING VALVE MOUNTING BRACKET  
(through Serial No. N3805084)**

Amana [Residential Amana HA6000 Washer Parts](#) Parts Diagram 08 - INLET/FILL HOSE/BACK FL PREVENTER & BRKT

[Click on the part number to view part](#)

Item	Original Part Number	Replaced By	Status	Part Description
1	Y00000000		Not Available	SEE NOTE MIXING VALVE
2	56392		Not Available	SCREW,8-18 X 3/8 TAPPI
3	27643	<a href="#">596669</a>		Clamp, Manifold
4	<a href="#">27183</a>			Hose, Mixing Valve
5	27152		Not Available	CLAMP HOSE
6	23962	<a href="#">W10116760</a>		Screw
7	27118	<a href="#">34280</a>		Assembly, Backflow Prevento
8	27231		Not Available	HOSE
9	<a href="#">54038</a>			NUT, Speed U-Type
10	27126	<a href="#">39407</a>		Bracket, Valve
11	Y00000000		Not Available	SEE NOTE CABINET
12	28330	<a href="#">202860</a>		Inlet Hose Assembly
13	20290	<a href="#">Y013783</a>		Washer, Inlet Hose
14	28605	<a href="#">22002960</a>		Strainer, Washer Inlet