

# Amana HG4280 15 - REAR BLKHD, FELT SEAL & CYLINDER ROLLER

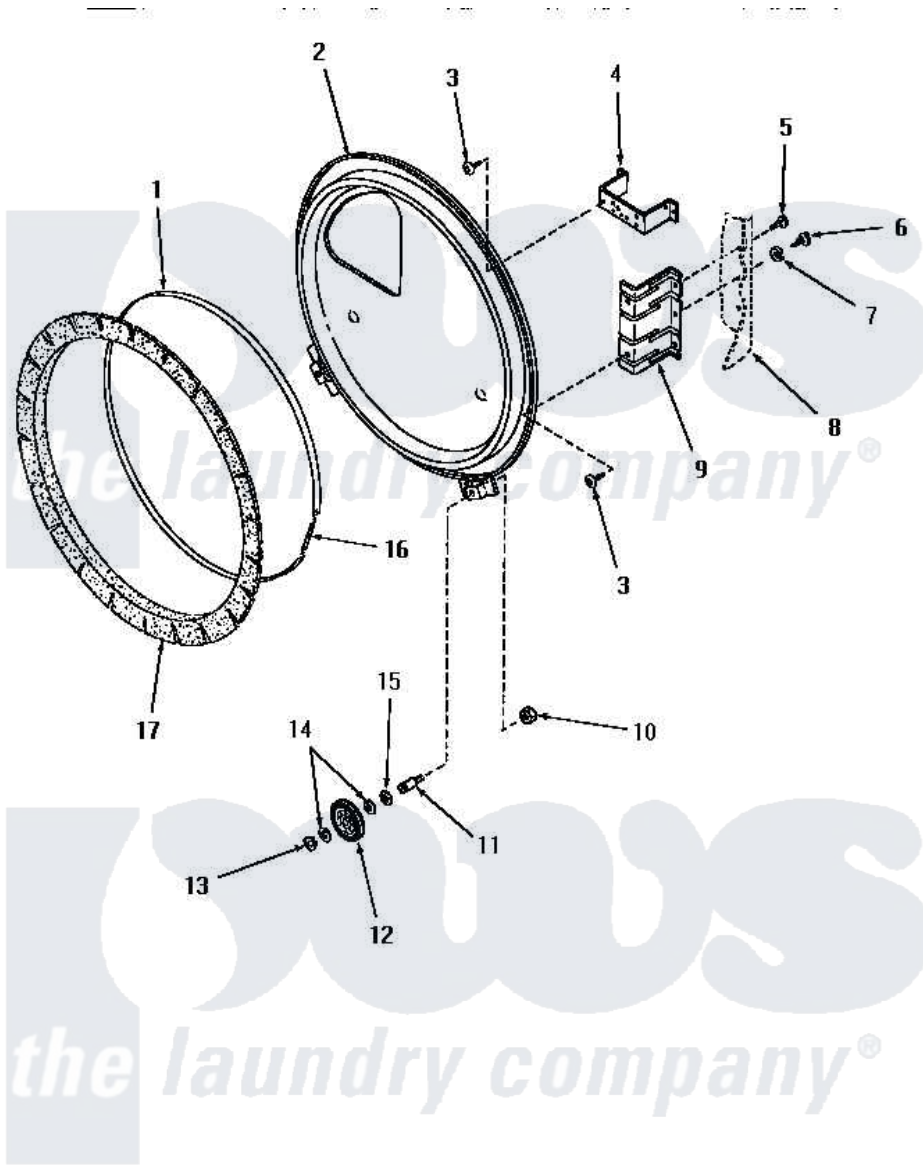

## REAR BULKHEAD, FELT SEAL AND CYLINDER ROLLER

Amana [Residential Amana HG4280 Dryer Parts](#) Parts Diagram 15 - REAR BLKHD, FELT SEAL & CYLINDER ROLLER  
 Click on the part number to view part

Item	Original Part Number	Replaced By	Status	Part Description
1	Y56090		Not Available	SEAL STRAP
2	56540		Not Available	ASSY,REAR BULKHEAD
3	56078	<a href="#">M400664</a>		SCrew Tap Trs Cr Rec 1016AB
4	56048	<a href="#">60823P</a>		Bracket, Terminal Block
5	25723	<a href="#">27001200</a>		Screw
6	<a href="#">52909</a>			Screw, 10B-16 X 1/2 HeX
7	51474		Not Available	WASHER, 13/64IDX1/2ODX.
8	Y00000000		Not Available	SEE NOTE CABINET
9	56055		Not Available	BRACKET,BULKHEAD-REAR
10	56156	<a href="#">358160</a>		Nut
11	<a href="#">56461</a>			Shaft
12	56457	<a href="#">62649P</a>		Roller- CY
13	<a href="#">23748</a>			Ring, Retaining
14	<a href="#">52549</a>			Washer, 501 ID X3/4 Odx
15	23886		Not Available	WASHER,.578IDX1.25ODX1
16	<a href="#">52310</a>			Spring

