

Amana HG5009 09 - GAS VALVE, IGNITER & GAS CONVERSION KITS

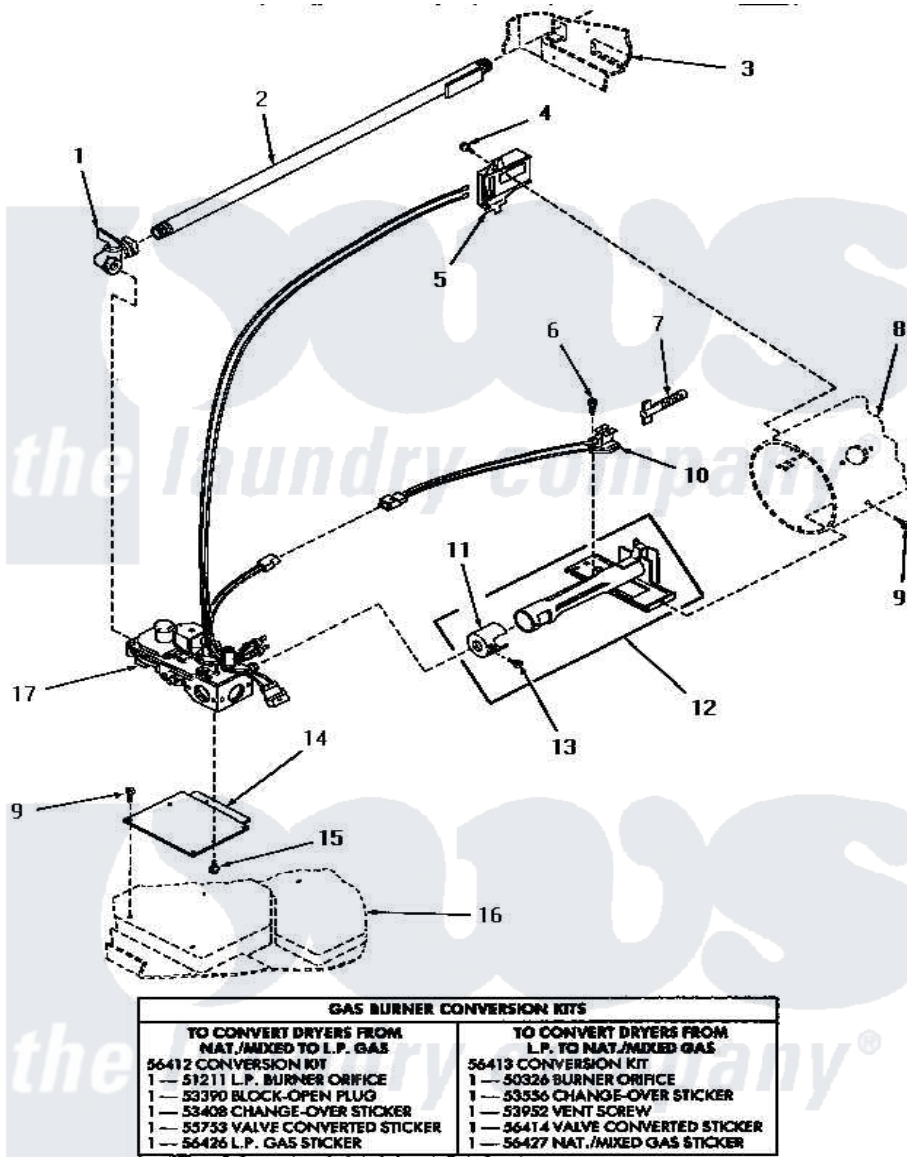

**GAS VALVE, IGNITER AND GAS CONVERSION KITS
(Gas Models)**

Amana [Residential Amana HG5009 Dryer Parts](#) Parts Diagram 09 - GAS VALVE, IGNITER & GAS CONVERSION KITS
Click on the part number to view part

Item	Original Part Number	Replaced By	Status	Part Description
1	Y56229	510205		Valve-Elbo
2	Y56228		Not Available	ASSY, LEAD-IN PIPE
3	Y00000000		Not Available	SEE NOTE CABINET
4	23222	3177991		Screw
5	Y56231	338906		Radiant, Sensor
6	52973		Not Available	SCREW
7	55438	4392003		Ignitor
8	Y00000000		Not Available	SEE NOTE BURNER HOUSING
9	56264	27001200		Screw
10	56233		Not Available	IGNITER BRACKET
11	53007	53-007		Receptacle
12	Y56234	37001304		Burner Ign
13	53006	53-006		Receptacle
14	56242		Not Available	BRACKET, MOUNTING-VALVE
15	56124	3370225		Screw

16	Y00000000	Not Available	SEE NOTE BASE
17	56225	Not Available	GAS VALVE ASSEMBLY
NI	53556	Not Available	STICKER,CONVERSION
"	50326		Orifice, NG
"	55753	Not Available	VALVE CONVERTED STICKER
"	53390		Plug, Block-Open
"	51211		Orifice, LP No.55 Drill
"	56414	Not Available	VALVE CONVERTED STICKER
"	56413	Not Available	ASSY,CONVERSION KIT-LP
"	Y56426	Not Available	L.P. GAS STICKERS
"	53408	Not Available	LABEL,CHANGE-OVER
"	53952		Screw, Vent
"	56412		Assembly, Conversion Kit-NG
"	56427	Not Available	STICKER

