

Amana HG6490 08 - GAS VALVE, IGN, TERM & GAS CONV KITS

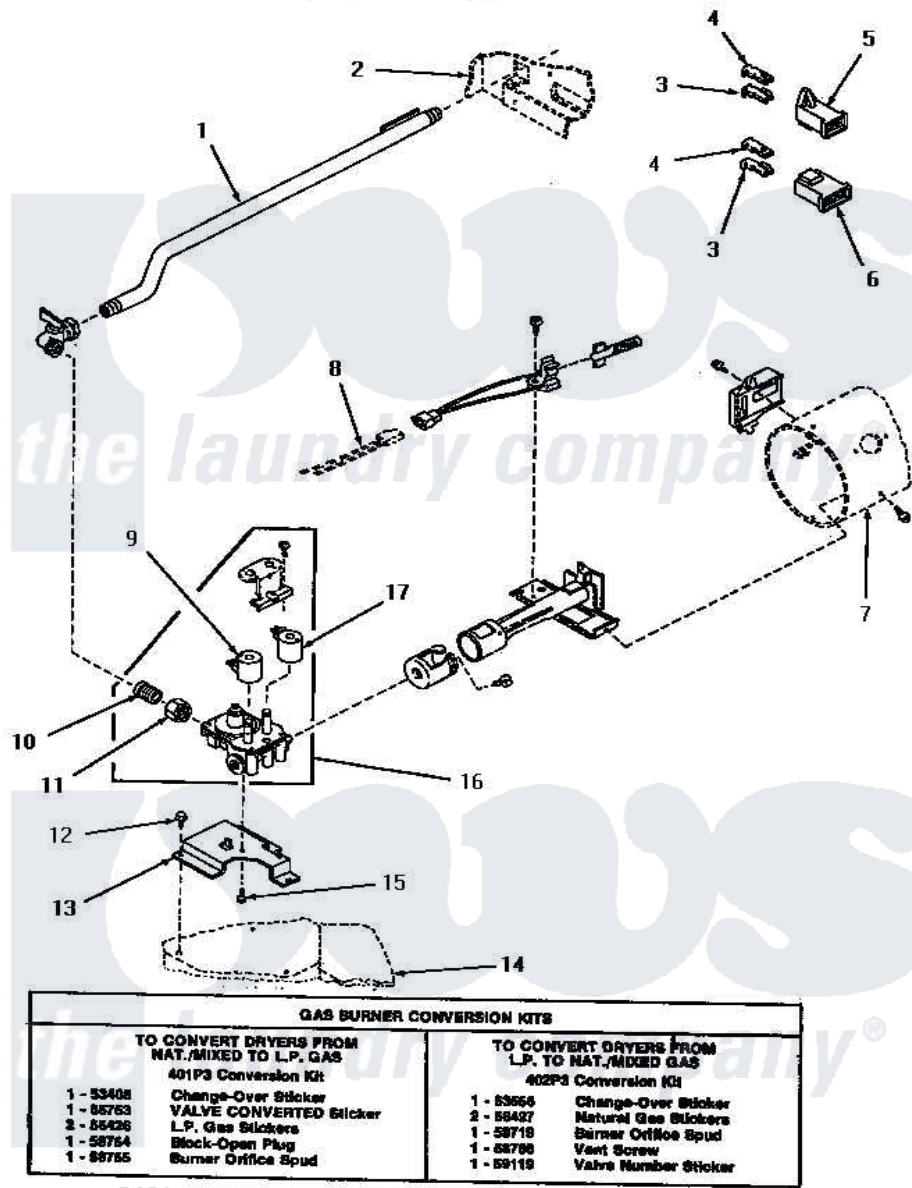

GAS VALVE, IGNITER, TERMINALS AND GAS CONVERSION KITS

Amana [Residential Amana HG6490 Washer Parts](#) Parts Diagram 08 - GAS VALVE, IGN, TERM & GAS CONV KITS
 Click on the part number to view part

Item	Original Part Number	Replaced By	Status	Part Description
1	58911			Assembly, Lead-In Pipe
2	Y00000000		Not Available	SEE NOTE CABINET
3	Y00190			Connector-Receptacle
4	Y00189			Terminal, Spade
5	58799			Connector-2 Circuit
6	58800		Not Available	CONNECTOR-3 CIRCUIT (3 CIRCUIT CONNECTOR)
7	Y00000000		Not Available	SEE NOTE BURNER HOUSING
8	Y00000000		Not Available	SEE NOTE WIRING HARNESS
9	58804A	306106		Coil, Holding And Booster--W
10	56282		Not Available	NIPPLE
11	Y58281		Not Available	NUT
12	56264	27001200		Screw
13	58912	500821		Bracket, Mounting-Gas
14	Y00000000		Not Available	SEE NOTE BASE

15	56124	3370225	Screw
16	58804		Assembly, Valve-Gas-Single-
17	58804B	694540	Coil, 60 Hz
NI	58754	401P3	Kit, Conversion-LP
"	58755	401P3	Kit, Conversion-LP
"	58719	402P3	Kit, Conversion-NG
"	58768	402P3	Kit, Conversion-NG
"	56427	Not Available	STICKER
"	59119	Not Available	LABEL
"	401P3		Kit, Conversion-LP
"	402P3		Kit, Conversion-NG
"	53408	Not Available	LABEL,CHANGE-OVER
"	53556	Not Available	STICKER,CONVERSION
"	55753	Not Available	VALVE CONVERTED STICKER
"	Y56426	Not Available	L.P. GAS STICKERS

