

Amana HG6490 09 - GAS VALVE, IGNITER & GAS CONVERSION KITS

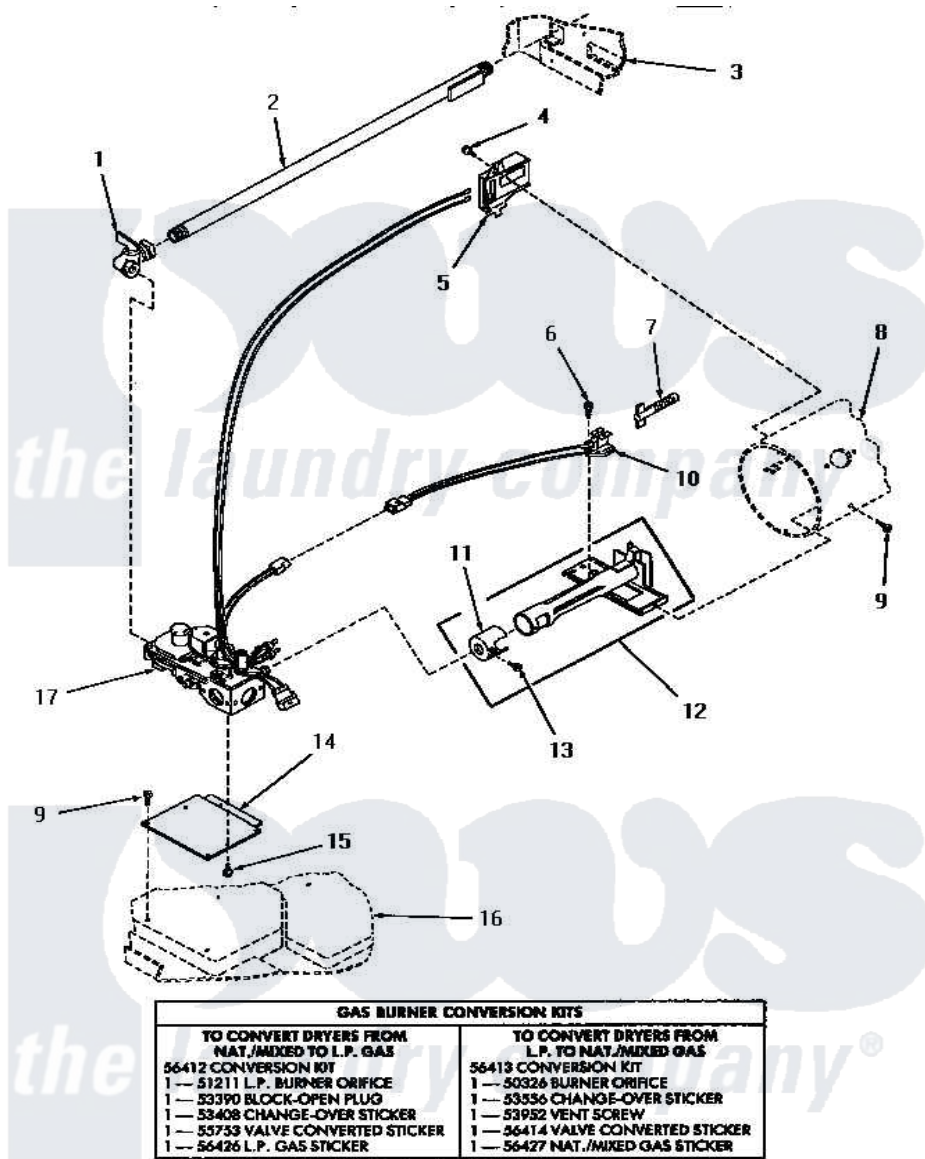

GAS BURNER CONVERSION KITS	
TO CONVERT DRYERS FROM NAT./MIXED TO L.P. GAS 56412 CONVERSION KIT 1 - 51211 L.P. BURNER ORIFICE 1 - 53390 BLOCK-OPEN PLUG 1 - 53408 CHANGE-OVER STICKER 1 - 53733 VALVE CONVERTED STICKER 1 - 56426 L.P. GAS STICKER	TO CONVERT DRYERS FROM L.P. TO NAT./MIXED GAS 56413 CONVERSION KIT 1 - 50326 BURNER ORIFICE 1 - 53536 CHANGE-OVER STICKER 1 - 53952 VENT SCREW 1 - 56414 VALVE CONVERTED STICKER 1 - 56427 NAT./MIXED GAS STICKER

GAS VALVE, IGNITER AND GAS CONVERSION KITS (Gas Models)

Amana [Residential Amana HG6490 Washer Parts](#) Parts Diagram 09 - GAS VALVE, IGNITER & GAS CONVERSION KITS

[Click on the part number to view part](#)

Item	Original Part Number	Replaced By	Status	Part Description
1	Y56229	510205		Valve-Elbo
2	Y56228		Not Available	ASSY,LEAD-IN PIPE
3	Y00000000		Not Available	SEE NOTE CABINET
4	23222	3177991		Screw
5	Y56231	338906		Radiant, Sensor
6	52973		Not Available	SCREW
7	55438	4392003		Ignitor
8	Y00000000		Not Available	SEE NOTE BURNER HOUSING
9	56264	27001200		Screw
10	56233		Not Available	IGNITER BRACKET
11	53007	53-007		Receptacle
12	Y56234	37001304		Burner Ign
13	53006	53-006		Receptacle
14	56242		Not Available	BRACKET,MOUNTING-VALVE

15	56124	3370225	Screw
16	Y00000000	Not Available	SEE NOTE BASE
17	56225	Not Available	GAS VALVE ASSEMBLY
NI	53556	Not Available	STICKER, CONVERSION
"	50326		Orifice, NG
"	55753	Not Available	VALVE CONVERTED STICKER
"	53390		Plug, Block-Open
"	51211		Orifice, LP No.55 Drill
"	56414	Not Available	VALVE CONVERTED STICKER
"	56413	Not Available	ASSY, CONVERSION KIT-LP
"	Y56426	Not Available	L.P. GAS STICKERS
"	53408	Not Available	LABEL, CHANGE-OVER
"	53952		Screw, Vent
"	56412		Assembly, Conversion Kit-NG
"	56427	Not Available	STICKER

