

Amana LE8107L2 (BOM: PLE8107L2) 06 - GRAPHIC PANEL, CONTROL HOOD AND CONTROLS

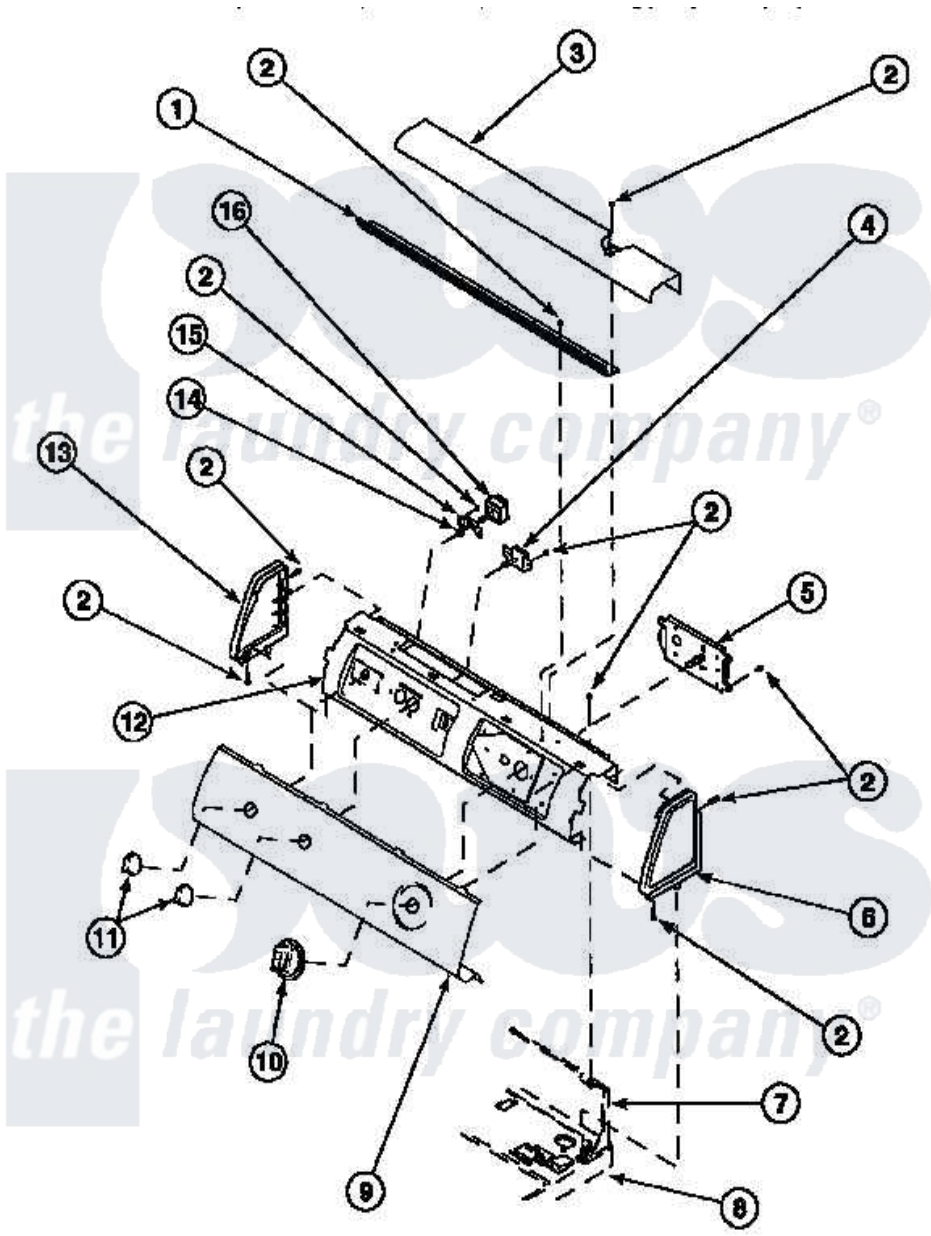

Amana Residential Amana LE8107L2 (BOM: PLE8107L2) Washer Parts Parts Diagram 06 - GRAPHIC PANEL, CONTROL HOOD AND CONTROLS
 Click on the part number to view part

Item	Original Part Number	Replaced By	Status	Part Description
1	500305		Not Available	DIFFUSER W/OUT HOLE
2	501086	90767		Screw, 8A X 3/8 HeX Washer Head Tapping
3	500303		Not Available	COVER, TOP
5	501881		Not Available	TIMER
6	34817		Not Available	END CAP(RIGHT)
7	500343		Not Available	PANEL,BACK(HOME HOOD)
8	500085P		Not Available	(ADD LETTER L-L, W-W TO PART N
10	502220		Not Available	KNOB, TIMER
12	500300		Not Available	BRACKET,CONTROL SUPPORT-MECH
13	34818		Not Available	END CAP(LEFT)