

**Amana LE8317L2 (BOM: PLE8317L2) 19 - REAR BLKHD/SEAL/CYLINDER ROLLER/TERM BLK**

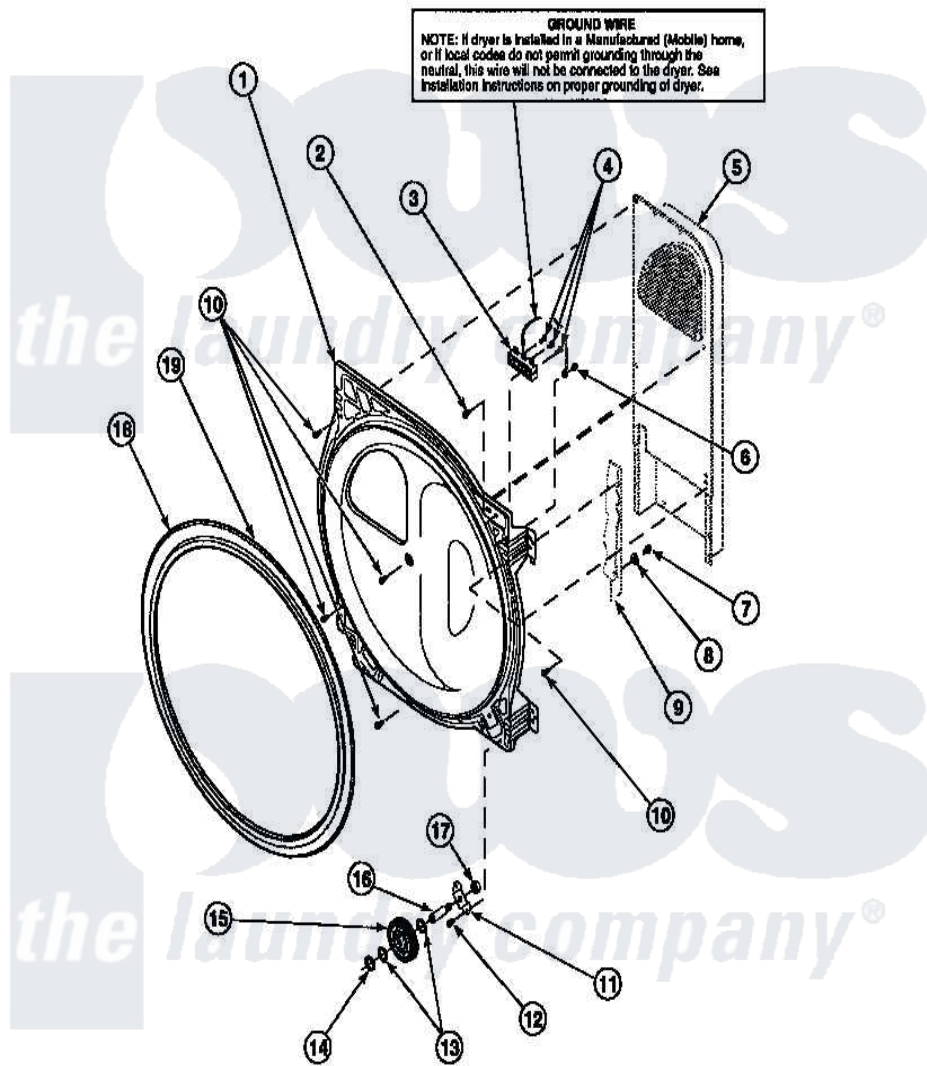

Amana Residential Amana LE8317L2 (BOM: PLE8317L2) Dryer Parts Parts Diagram 19 - REAR BLKHD/SEAL/CYLINDER ROLLER/TERM BLK  
Click on the part number to view part

Item	Original Part Number	Replaced By	Status	Part Description
1	502614W	<a href="#">502614WP</a>		Bulkhead, Rear
"	Y501154		Not Available	ASSY, BULKHEAD
2	<a href="#">501285</a>			Screw, No.12 X 9/16-Pla
3	61923P	<a href="#">61923</a>		Block, Terminal
4	Y61199	<a href="#">3400094</a>		Screw, 10-32 X 3/8
5	500179P	<a href="#">503605</a>		Assembly, Heater Duct
6	<a href="#">20530</a>			Screw, 10-24 x 3/8 Hex
7	<a href="#">20530</a>			Screw, 10-24 x 3/8 Hex
8	51474		Not Available	WASHER, 13/64IDX1/2ODX.
9	500001P		Not Available	(ADD LETTER BEFORE "P" IN PART
10	501668	<a href="#">503688</a>		Screw, 10B-16 X .34 I
11	500062	<a href="#">40113601</a>		Assembly, Roller Brkt
12	501668	<a href="#">503688</a>		Screw, 10B-16 X .34 I
13	<a href="#">52549</a>			Washer, 501 ID X3/4 Odx

14	<a href="#">23748</a>		Ring, Retaining
15	500214P	<a href="#">37001042</a>	Assembly, Cylinder Roller
16	<a href="#">56461</a>		Shaft
17	56156	<a href="#">358160</a>	Nut
18	501801	<a href="#">37001132</a>	Seal, Cylinder
19	22506P	<a href="#">511637P</a>	Adh Dow 737 Clr 3 Oz Tube

