

**Amana LE8367W2 (BOM: PLE8367W2) 03 - FR BLKHD, AIR DUCT, FELT SEAL & CYLINDER**

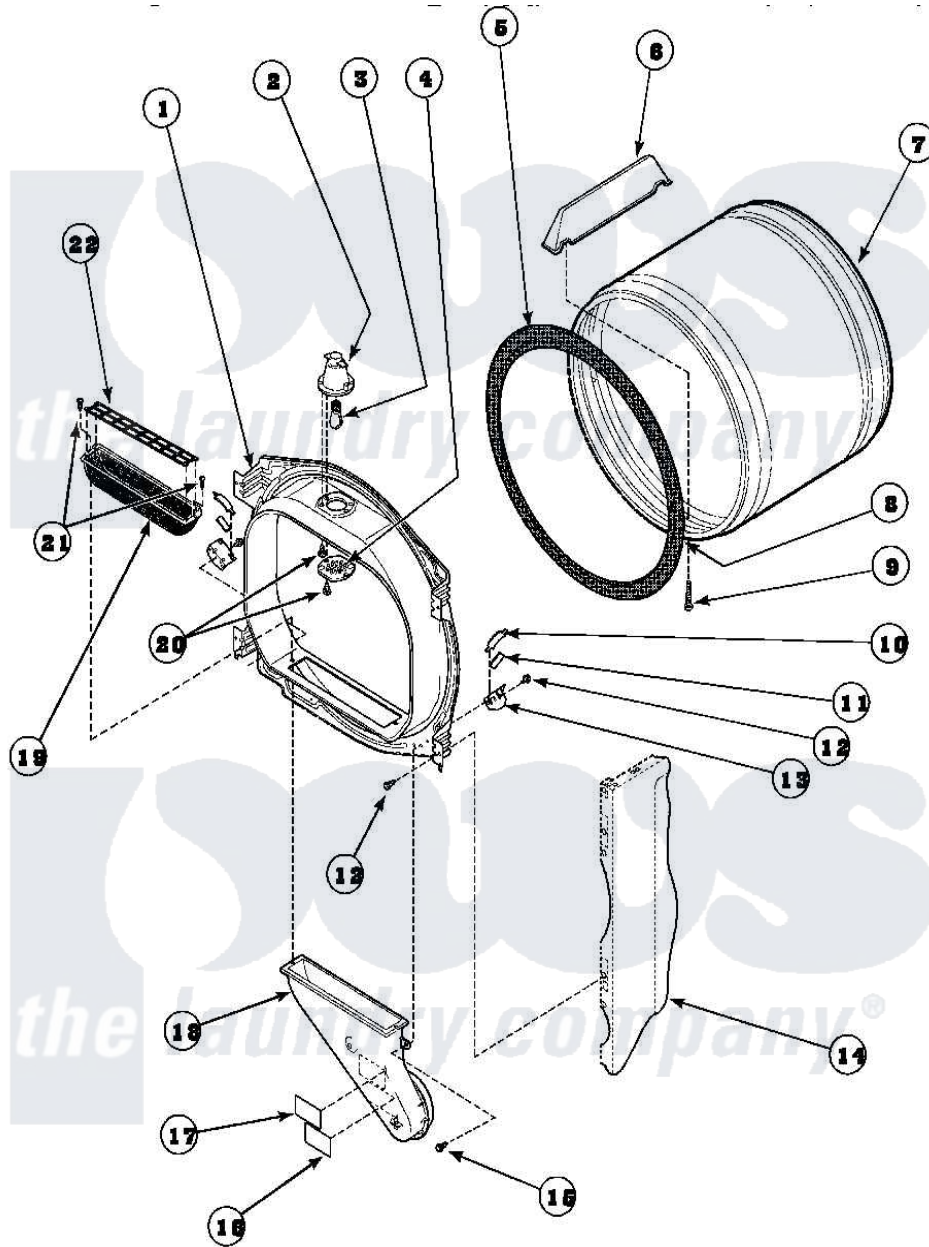

Amana Residential Amana LE8367W2 (BOM: PLE8367W2) Dryer Parts Parts Diagram 03 - FR BLKHD, AIR DUCT, FELT SEAL & CYLINDER

Click on the part number to view part

Item	Original Part Number	Replaced By	Status	Part Description
1	501570WP		Not Available	ASSY BULKHEAD
"	<a href="#">500016W</a>			Assembly, Bulkhead Front Complete
"	500117W		Not Available	ASSY,BULKHEAD-FRONT-COMP
2	500153		Not Available	CYLINDER LIGHT HOUSING
3	501801	<a href="#">37001132</a>		Seal, Cylinder
4	Y60954	<a href="#">67001316</a>		Bulb, Light
5	500094		Not Available	LENS,DRUM LIGHT
6	500022	<a href="#">510102</a>		Baffle- SH
7	500735P		Not Available	ASSY,CYLINDER-HOME
"	500013WP		Not Available	ASSY,CYLINDER-HOME-
8	22506P	<a href="#">511637P</a>		Adh Dow 737 Clr 3 Oz Tube
9	<a href="#">Y62588</a>			Screw, 10BT-12 X 1 Tap
10	Y501676	<a href="#">37001298</a>		Glide- Dry

"	501553	<a href="#">37001298</a>		Glide- Dry
11	500121	<a href="#">510189</a>		Pad Felt
12	501668	<a href="#">503688</a>		Screw, 10B-16 X .34 I
13	501554	<a href="#">12002090</a>		Bracket
14	500001P		Not Available	(ADD LETTER BEFORE "P" IN PART
15	Y31645	<a href="#">27001200</a>		Screw
16	56259		Not Available	STICKER
17	500049		Not Available	STICKER
18	502231		Not Available	DUCT, HEAT
19	<a href="#">502140P</a>			Filter, Lint Kit
20	500227	<a href="#">505295</a>		Screw, No.8ab-16 x 3/4 PH
21	<a href="#">500226</a>			Screw, 8b-16 x 5/8 Tap
22	<a href="#">502092</a>			Cover, Lint Filter

*the laundry company*<sup>®</sup>

**Howes**  
*the laundry company*<sup>®</sup>

**Howes**  
*the laundry company*<sup>®</sup>