

Amana LE8407W2 (BOM: PLE8407W2) 07 - GRAPHIC PANEL, CONTROL HOOD AND CONTROLS

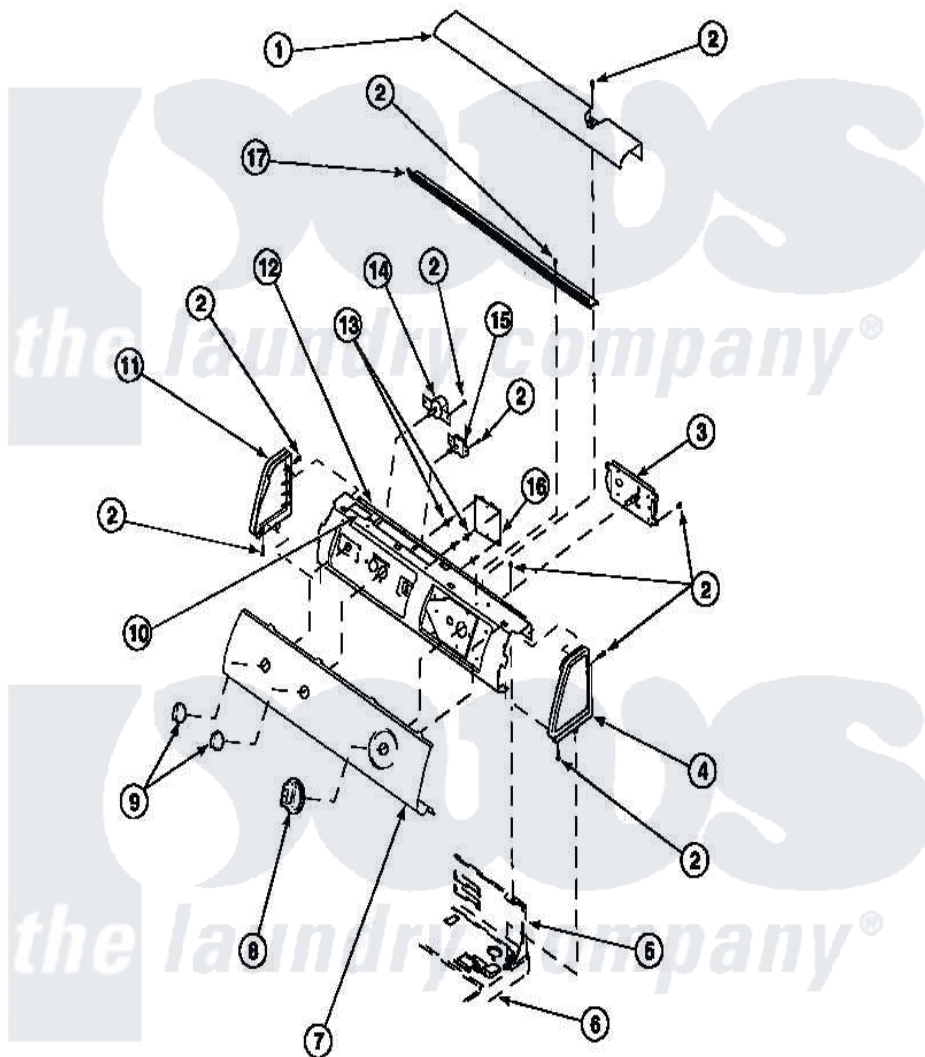

Amana Residential Amana LE8407W2 (BOM: PLE8407W2) Dryer Parts Parts Diagram 07 - GRAPHIC PANEL, CONTROL HOOD AND CONTROLS
 Click on the part number to view part

Item	Original Part Number	Replaced By	Status	Part Description
1	500303		Not Available	COVER, TOP
2	501086	90767		Screw, 8A X 3/8 HeX Washer Head Tapping
3	502967	502967P		Timer 5 Cycle Package
"	501881		Not Available	TIMER
4	34817		Not Available	END CAP(RIGHT)
5	500343		Not Available	PANEL,BACK(HOME HOOD)
6	500085P		Not Available	(ADD LETTER L-L, W-W TO PART N
8	502220		Not Available	KNOB, TIMER
9	36701		Not Available	KNOB, TEMP
10	24903		Not Available	STICKER,DISCONNECT POW
11	34818		Not Available	END CAP(LEFT)
12	500300		Not Available	BRACKET,CONTROL SUPPORT-MECH

