

**Amana LE8407W2 (BOM: PLE8407W2) 08 - GRAPHIC PANEL, CONTROL HOOD AND CONTROLS**

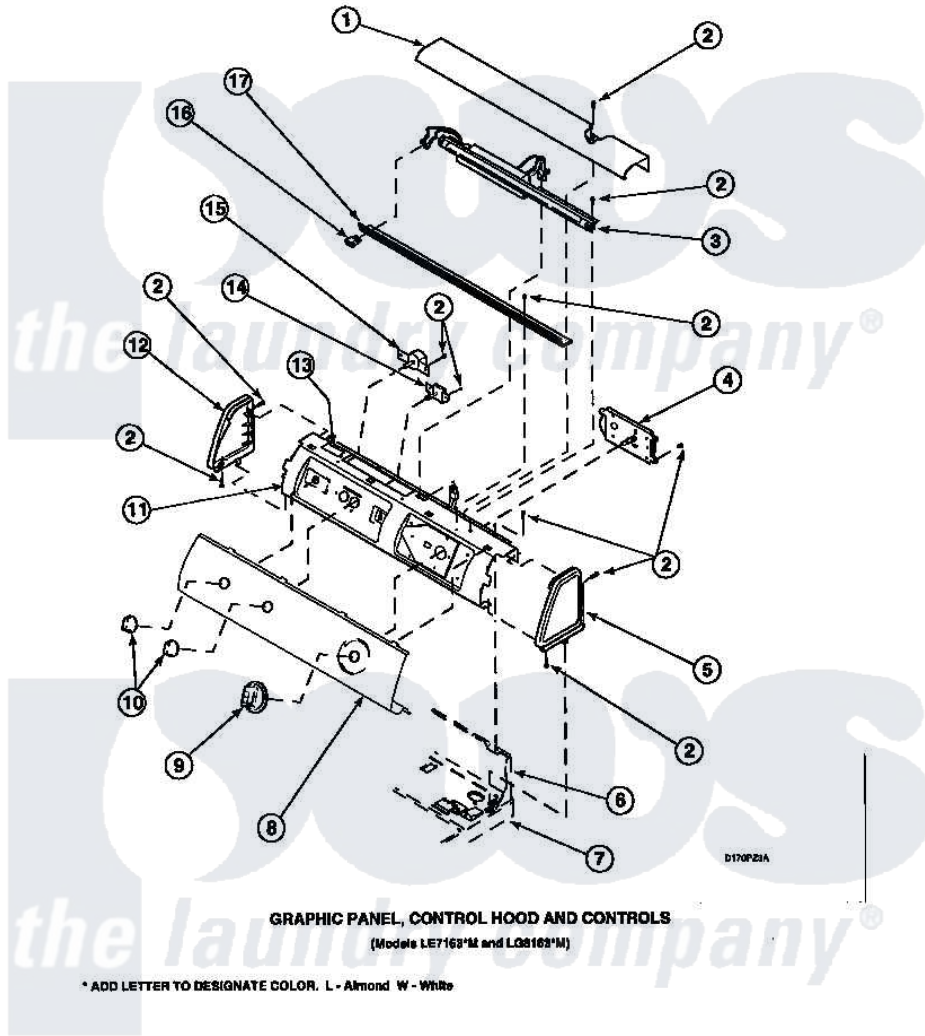

RP3200001 (502957) Revision 3 12

Amana Residential Amana LE8407W2 (BOM: PLE8407W2) Dryer Parts Parts Diagram 08 - GRAPHIC PANEL, CONTROL HOOD AND CONTROLS  
Click on the part number to view part

Item	Original Part Number	Replaced By	Status	Part Description
1	500303		Not Available	COVER, TOP
2	501086	<a href="#">90767</a>		Screw, 8A X 3/8 HeX Washer Head Tapping
4	502967	<a href="#">502967P</a>		Timer 5 Cycle Package
5	34817		Not Available	END CAP(RIGHT)
6	500343		Not Available	PANEL,BACK(HOME HOOD)
7	500085P		Not Available	(ADD LETTER L-L, W-W TO PART N
9	502220		Not Available	KNOB, TIMER
10	36701		Not Available	KNOB, TEMP
11	500300		Not Available	BRACKET,CONTROL SUPPORT-MECH
12	34818		Not Available	END CAP(LEFT)
13	24903		Not Available	STICKER,DISCONNECT POW
14	<a href="#">500823</a>			Signal, Rotary