

Amana LE8517L2 (BOM: PLE8517L2) 08 - GRAPHIC PANEL, CONTROL HOOD AND CONTROLS

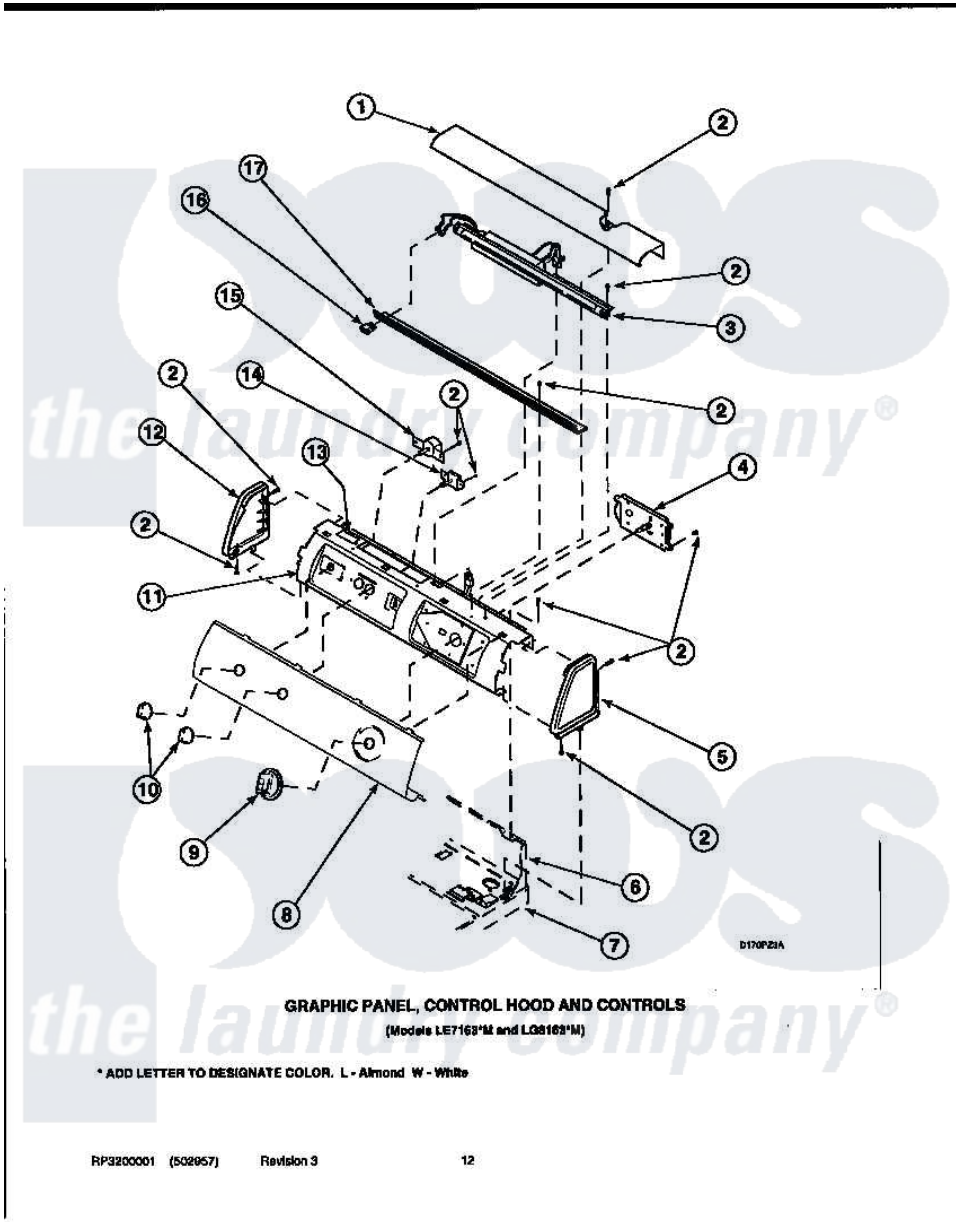

Amana Residential Amana LE8517L2 (BOM: PLE8517L2) Dryer Parts Parts Diagram 08 - GRAPHIC PANEL, CONTROL HOOD AND CONTROLS

Click on the part number to view part

Item	Original Part Number	Replaced By	Status	Part Description
1	500303		Not Available	COVER, TOP
2	501086	90767		Screw, 8A X 3/8 HeX Washer Head Tapping
4	502967	502967P		Timer 5 Cycle Package
5	34817		Not Available	END CAP(RIGHT)
6	500343		Not Available	PANEL,BACK(HOME HOOD)
7	500085P		Not Available	(ADD LETTER L-L, W-W TO PART N
9	502220		Not Available	KNOB, TIMER
10	36701		Not Available	KNOB, TEMP
11	500300		Not Available	BRACKET,CONTROL SUPPORT-MECH
12	34818		Not Available	END CAP(LEFT)
13	24903		Not Available	STICKER,DISCONNECT POW
14	500823			Signal, Rotary