

**Amana LE8517L2 (BOM: PLE8517L2) 09 - GRAPHIC PANEL, CONTROL HOOD AND CONTROLS**

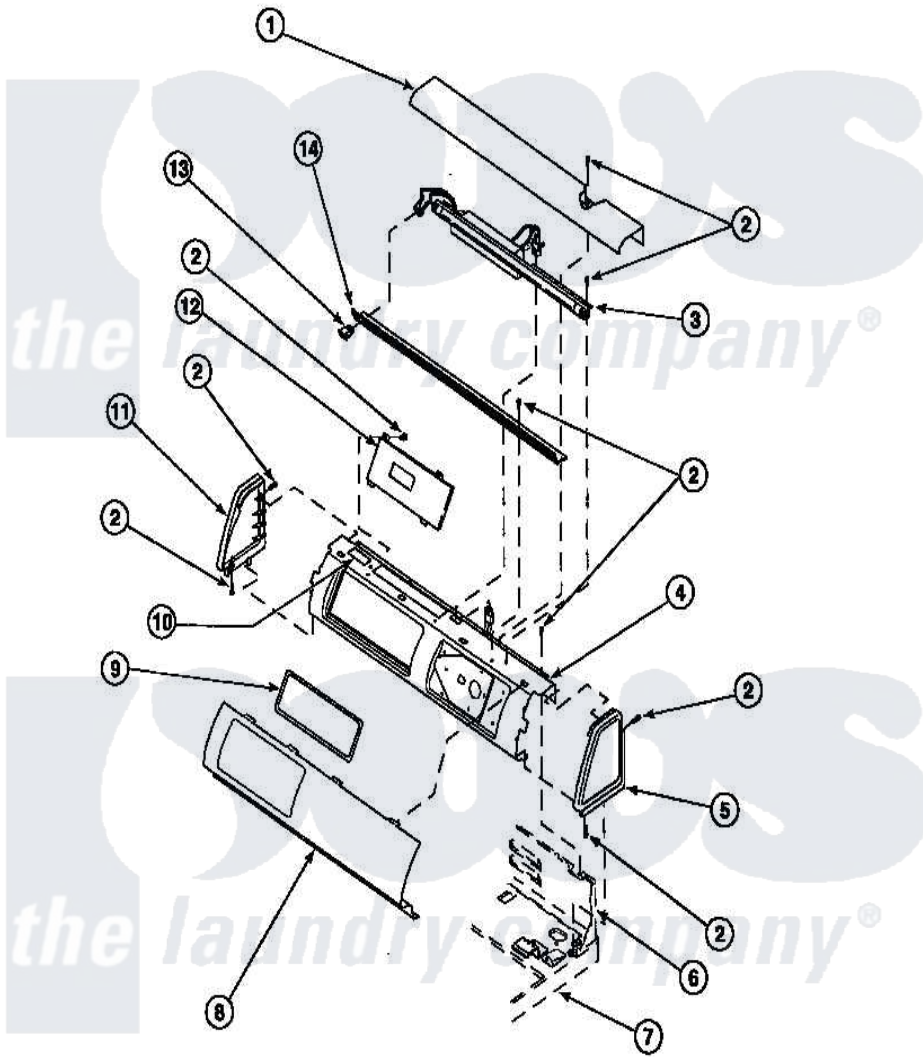

Amana Residential Amana LE8517L2 (BOM: PLE8517L2) Dryer Parts Parts Diagram 09 - GRAPHIC PANEL, CONTROL HOOD AND CONTROLS

[Click on the part number to view part](#)

Item	Original Part Number	Replaced By	Status	Part Description
1	500303		Not Available	COVER, TOP
2	501086	<a href="#">90767</a>		Screw, 8A X 3/8 HeX Washer Head Tapping
5	34817		Not Available	END CAP(RIGHT)
6	500343		Not Available	PANEL,BACK(HOME HOOD)
7	500085P		Not Available	(ADD LETTER L-L, W-W TO PART N
10	24903		Not Available	STICKER,DISCONNECT POW
11	34818		Not Available	END CAP(LEFT)