

Amana LE8567L2 (BOM: PLE8567L2) 07 - GRAPHIC PANEL, CONTROL HOOD AND CONTROLS

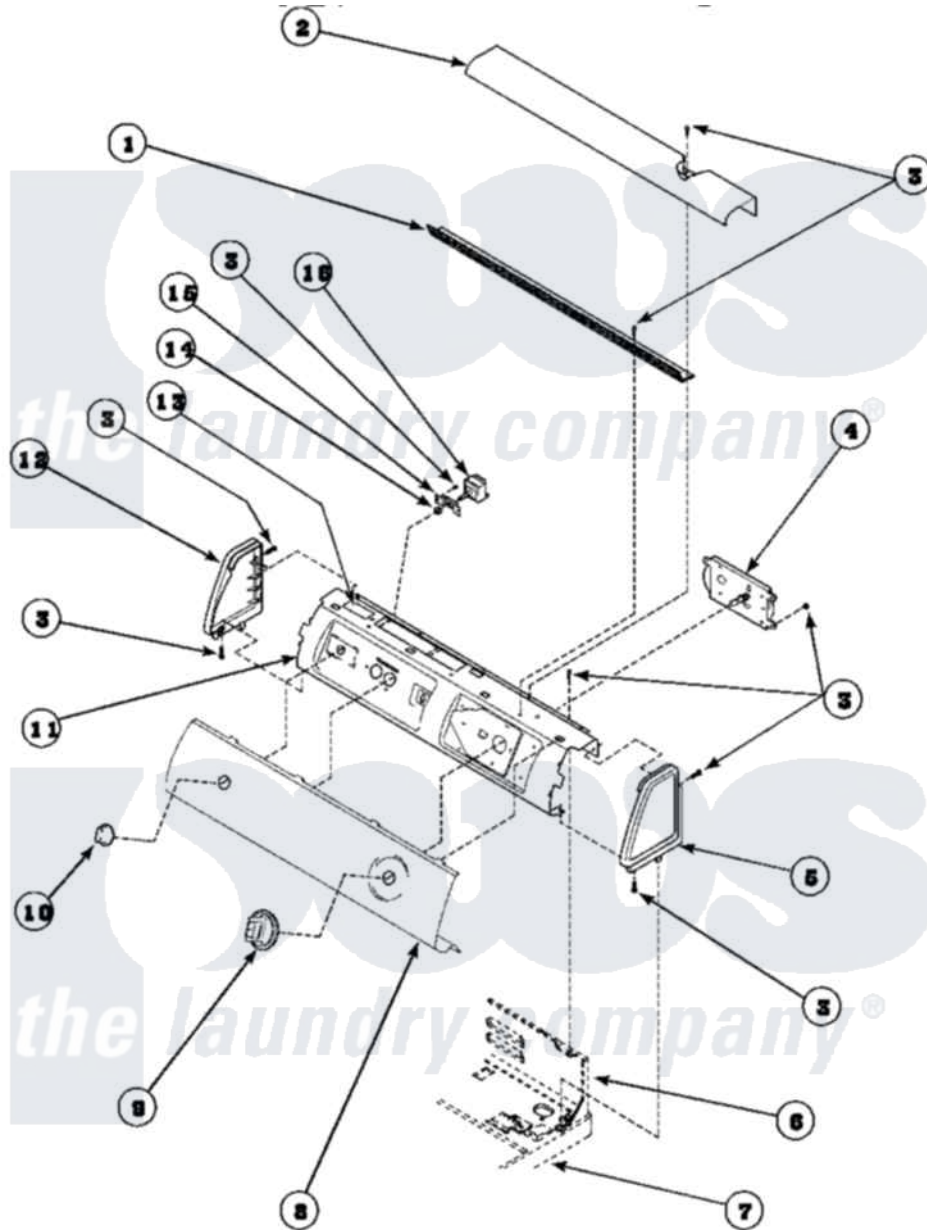

Amana Residential Amana LE8567L2 (BOM: PLE8567L2) Dryer Parts Parts Diagram 07 - GRAPHIC PANEL, CONTROL HOOD AND CONTROLS

[Click on the part number to view part](#)

Item	Original Part Number	Replaced By	Status	Part Description
1	500305		Not Available	DIFFUSER W/OUT HOLE
2	500303		Not Available	COVER, TOP
3	501086	90767		Screw, 8A X 3/8 HeX Washer Head Tapping
4	501881		Not Available	TIMER
5	34817		Not Available	END CAP(RIGHT)
6	500343		Not Available	PANEL,BACK(HOME HOOD)
7	500085P		Not Available	(ADD LETTER L-L, W-W TO PART N
8	Y503254		Not Available	GRAPHIC PANEL
9	502220		Not Available	KNOB, TIMER
10	36701		Not Available	KNOB, TEMP
11	500300		Not Available	BRACKET,CONTROL SUPPORT-MECH
12	34818		Not Available	END CAP(LEFT)
13	24903		Not Available	STICKER,DISCONNECT

13	24903	Not Available	POW
14	57584	Not Available	NUT
15	59704		Bracket, Switch Mount
16	Y61511	Not Available	SWITCH,FABRIC SELECTOR

