

Amana LE9207W (BOM: P1163710W W) 05 - GRAPHIC PANEL, CONTROL HOOD & CONTROLS

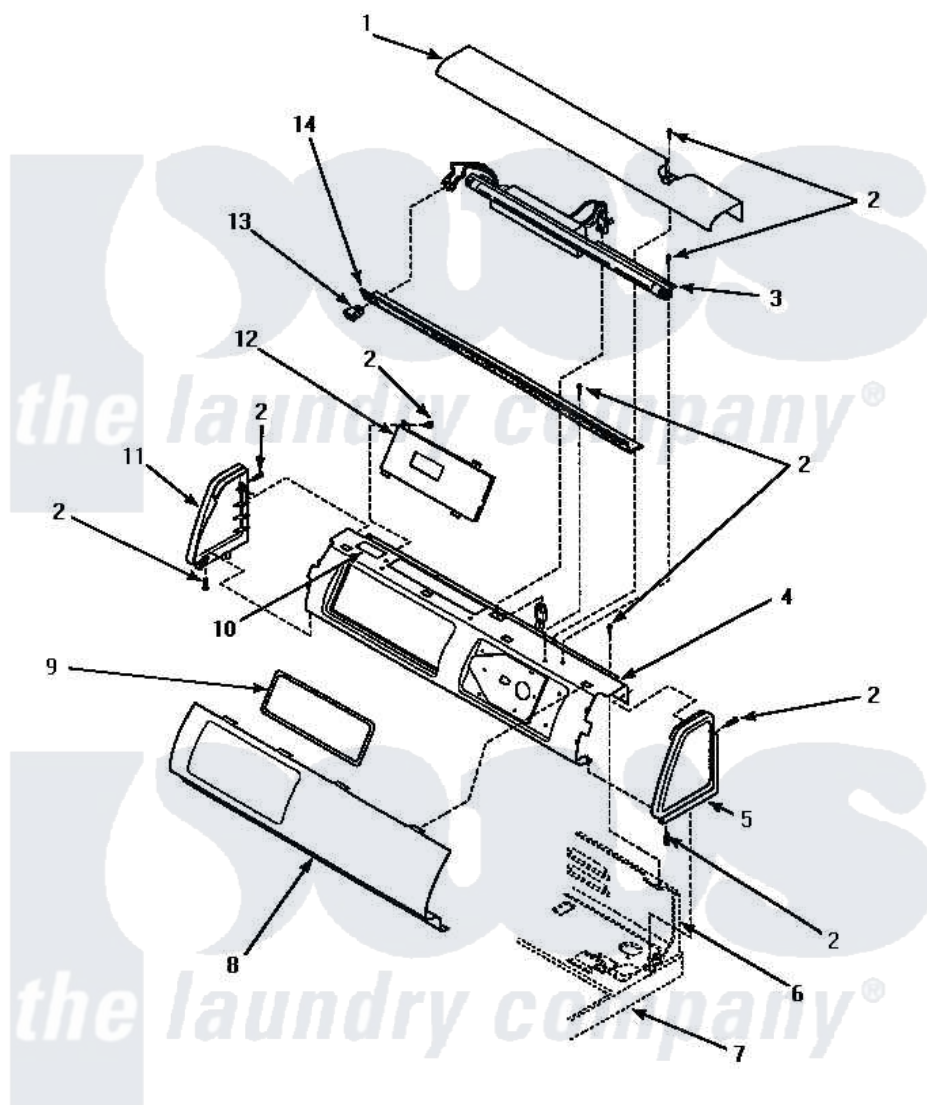

GRAPHIC PANEL, CONTROL HOOD AND CONTROLS

Amana [Residential Amana LE9207W \(BOM: P1163710W W\) Dryer Parts](#) Parts Diagram 05 - GRAPHIC PANEL, CONTROL HOOD & CONTROLS
 Click on the part number to view part

Item	Original Part Number	Replaced By	Status	Part Description
"	NOTE:		Not Available	IF DRYER IS INSTALLED IN A MANUFACTURED (MOBILE) HOME, OR IF LOCAL CODES DO NOT PERMIT GROUNDING THROUGH THE NEUTRAL, THIS WIRE WILL NOT BE CONNECTED TO THE DR
1	500303W			Cover, Top
2	501086	90767		Screw, 8A X 3/8 HeX Washer Head Tapping
3	34836			Assembly, Fluorescent Light
"	34841		Not Available	STARTER,FLUORESCENT
"	34837		Not Available	BULB,FLUORESCENT
4	500301			Bracket, Electronic Control
5	34817W		Not Available	PANEL,END-RH
6	Y00000000		Not Available	SEE NOTE CONTROL HOOD REAR PANEL

7	Y0000000	Not Available	SEE NOTE CABINET TOP
8	500529W	Not Available	PANEL,GRAPHIC
9	Y500528	Not Available	GASKET,ELECTRONIC CONTROL
10	24903	Not Available	STICKER,DISCONNECT POW
11	34818W	Not Available	PANEL,END-LH
12	500540W	Not Available	KIT, ELECTRONIC TIMER
13	35038	Not Available	SWITCH/ WHITE
14	500308	Not Available	DIFFUSER W/HOLE

