

Amana LEA50AW (BOM: PLEA50AW) 07 - REAR BULKHEAD, FELT SEAL & ROLLERS

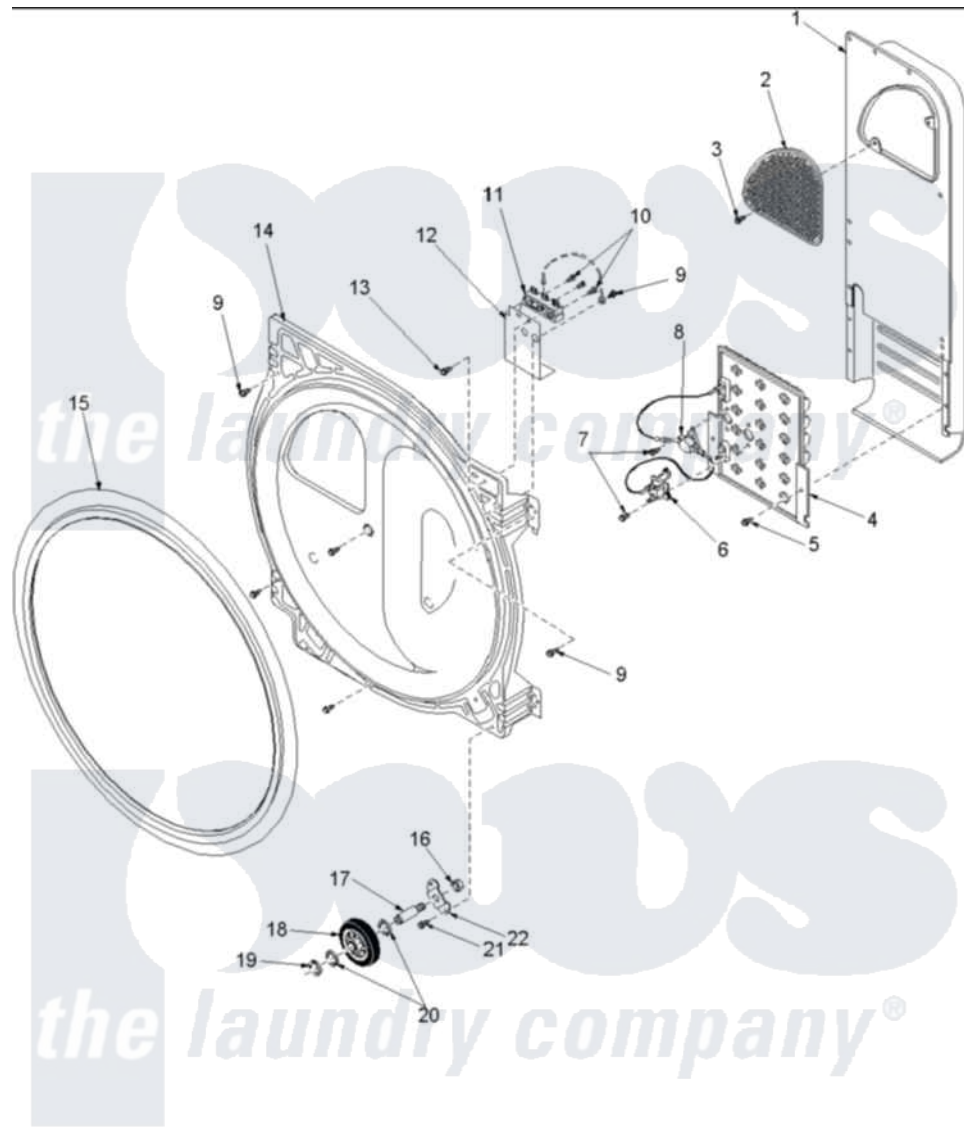

Amana Residential Amana LEA50AW (BOM: PLEA50AW) Dryer Parts Parts Diagram 07 - REAR BULKHEAD, FELT SEAL & ROLLERS

[Click on the part number to view part](#)

Item	Original Part Number	Replaced By	Status	Part Description
1	503490	503605		Assembly, Heater Duct
2	500074	503605		Assembly, Heater Duct
4	Y503978			Assembly, Heater Kit
5	503688			Screw, 10B-16 X .34 I
6	62600	40113801		Fuse, Thermal
7	23222	3177991		Screw
8	Y62641	W10116735		Thermistor-Fix
10	501285			Screw, No.12 X 9/16-Pla
11	61923			Block, Terminal
12	Y504185			Shield, Terminal Block
13	501285			Screw, No.12 X 9/16-Pla
14	504801W	502614WP		Bulkhead, Rear
15	501801	37001132		Seal, Cylinder
16	56156	358160		Nut
17	56461			Shaft

18	500214	37001042	Assembly, Cylinder Roller
19	23748		Ring, Retaining
20	52549		Washer, 501 ID X3/4 Odx
21	503688		Screw, 10B-16 X .34 I
22	500062	40113601	Assembly, Roller Brkt

