

# Amana LEA60AW (BOM: PLEA60AW) 09 - TERMINALS AND MOTOR CONNECTION BLOCK

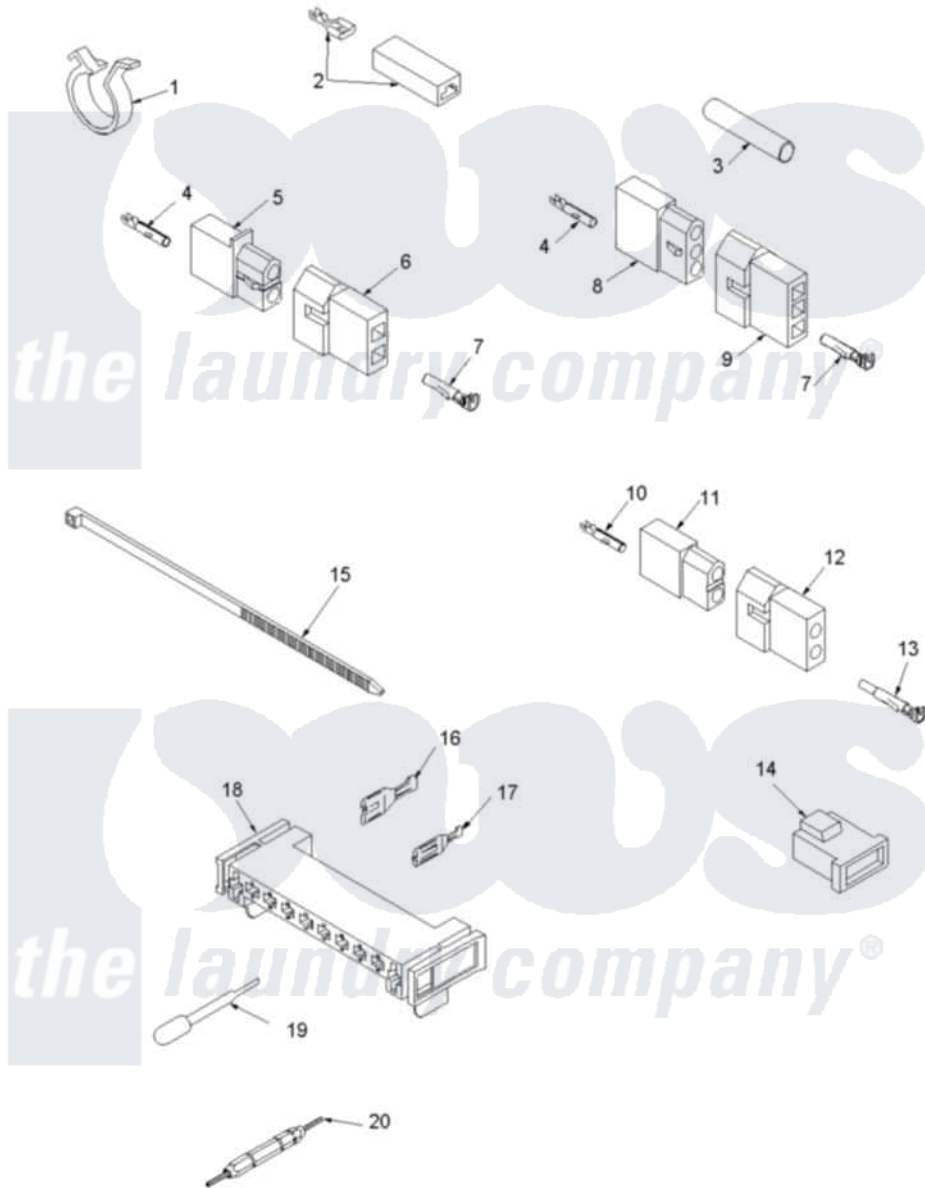

Amana Residential Amana LEA60AW (BOM: PLEA60AW) Dryer Parts Parts Diagram 09 - TERMINALS AND MOTOR CONNECTION BLOCK

[Click on the part number to view part](#)

Item	Original Part Number	Replaced By	Status	Part Description
1	<a href="#">504034</a>			Clip, Wire
2	<a href="#">Y00237</a>			Terminal-Female 1/4 ((1) 12 GAuge Wire Or(2) 18 GA
3	Y21365	<a href="#">503670</a>		Sleeve Insulator
4	Y00117	<a href="#">5011-XX</a>		093 Female Socket
5	<a href="#">56451</a>			Receptacle, 2 Circuit
6	<a href="#">56448</a>			Terminal Block Plug
7	<a href="#">Y00116</a>			Terminal, Pin-Male
8	23039	<a href="#">697780</a>		Receptacle,
9	<a href="#">23040</a>			Plug-3 Circuit
10	<a href="#">00130</a>			Terminal, Pin-1/8 Femal
11	<a href="#">56265</a>			Receptacle, 2 Circuit
12	<a href="#">56266</a>			Plug
13	<a href="#">Y00127</a>			Terminal, Pin-1/8 Male
14	58800		Not Available	CONNECTOR-3 CIRCUIT (3

14	36466	<a href="#">M0321209</a>	Not Available	CIRCUIT CONNECTOR)
15	36466			Tie-Electrical
16	<a href="#">Y00256</a>			Spade Terminal Or
"	00255		Not Available	(1/4 INCH-FOR (1) 12 GAUGE WIR
17	<a href="#">Y00188</a>			Molex Terminal
18	<a href="#">500338</a>			Housing-10 Position
19	<a href="#">283P4</a>			Terminal Extractor Tool
20	<a href="#">190P4</a>			Terminal Extractor Tool

