

**Amana LG4309W (BOM: P1163503W W) 01 - BULKHEAD/FELT SEAL/CYL ROLLER & TERM BLK**

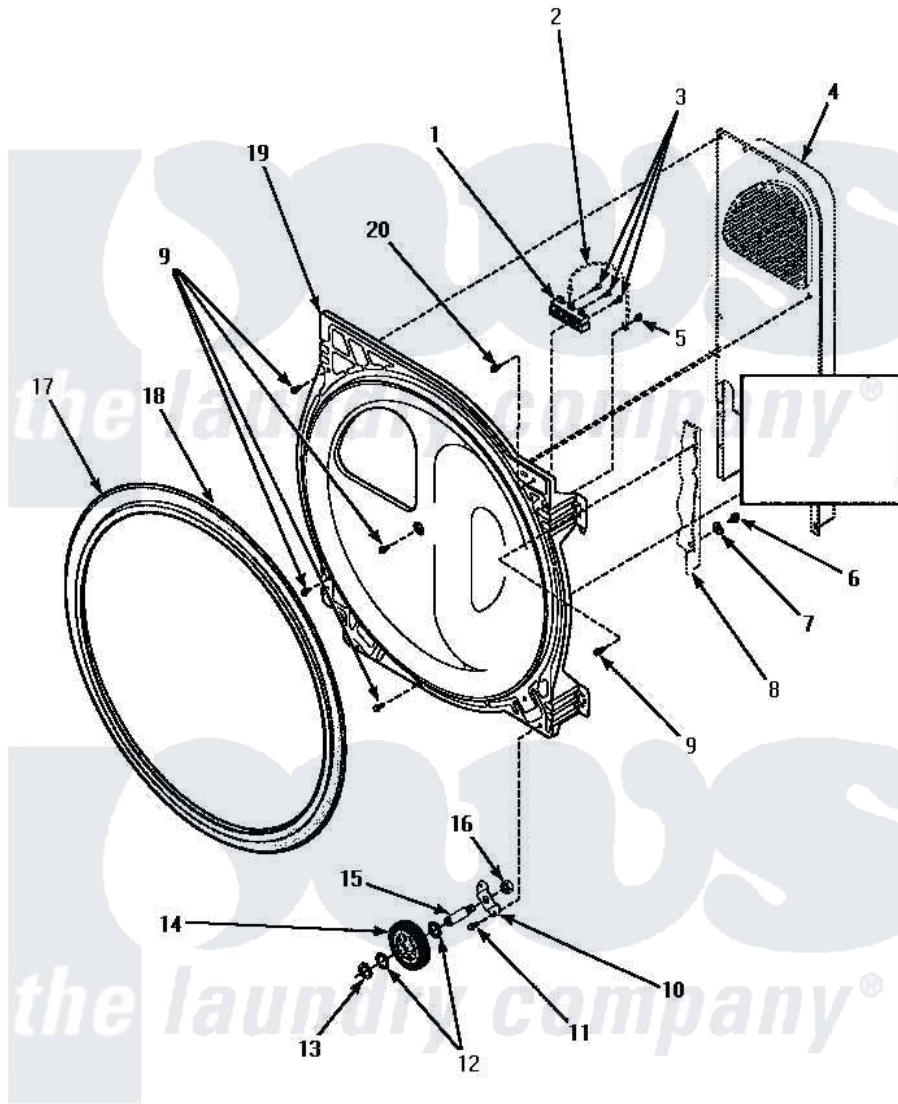

**REAR BULKHEAD, FELT SEAL, CYLINDER ROLLER AND TERMINAL BLOCK**

Amana [Residential Amana LG4309W \(BOM: P1163503W W\) Dryer Parts](#) Parts Diagram 01 - BULKHEAD/FELT SEAL/CYL ROLLER & TERM BLK  
 Click on the part number to view part

Item	Original Part Number	Replaced By	Status	Part Description
1	61923P	<a href="#">61923</a>		Block, Terminal
2	Y00000000		Not Available	SEE NOTE GROUND WIRE, GREEN -- (SEE NOTE)
3	Y61199	<a href="#">3400094</a>		Screw, 10-32 X 3/8
4	Y00000000		Not Available	SEE NOTE HEATER BOX ASSEMBLY
5	<a href="#">20530</a>			Screw, 10-24 x 3/8 Hex
6	<a href="#">20530</a>			Screw, 10-24 x 3/8 Hex
7	51474		Not Available	WASHER, 13/64IDX1/2ODX.
8	Y00000000		Not Available	SEE NOTE CABINET
9	501668	<a href="#">503688</a>		Screw, 10B-16 X .34 I
10	500062	<a href="#">40113601</a>		Assembly, Roller Brkt
11	501668	<a href="#">503688</a>		Screw, 10B-16 X .34 I
12	<a href="#">52549</a>			Washer, 501 ID X3/4 Odx
13	<a href="#">23748</a>			Ring, Retaining

14	500214	<a href="#">37001042</a>	Assembly, Cylinder Roller
15	<a href="#">56461</a>		Shaft
16	56156	<a href="#">358160</a>	Nut
17	501801	<a href="#">37001132</a>	Seal, Cylinder
18	22506P	<a href="#">511637P</a>	Adh Dow 737 Clr 3 Oz Tube
19	500356W	<a href="#">502614WP</a>	Bulkhead, Rear
20	<a href="#">501285</a>		Screw, No.12 X 9/16-Pla

