

Amana LG4909W (BOM: P1163714W W) 12 - MTR CONN BLOCK/TERM & EXTRACTOR TOOL

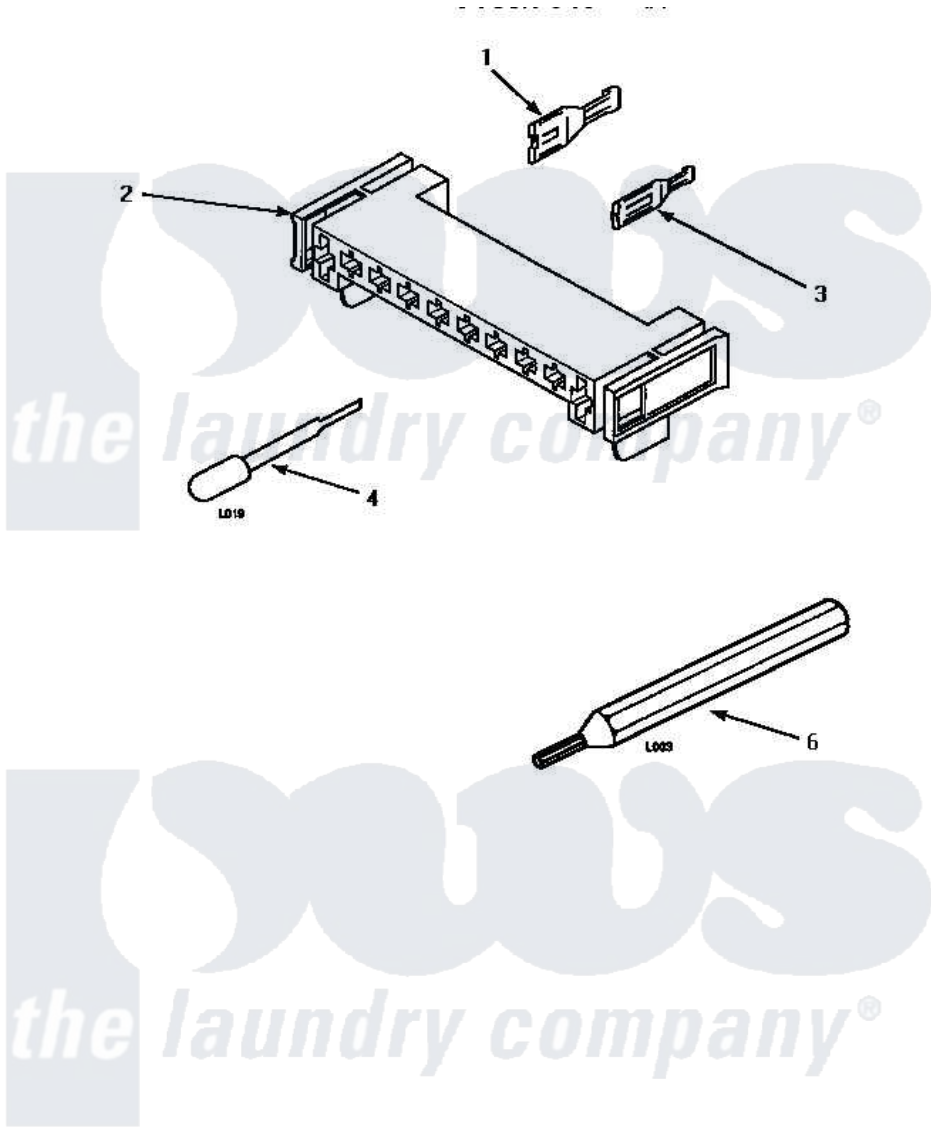

MOTOR CONNECTION BLOCK, TERMINALS AND TERMINAL EXTRACTOR TOOLS

Amana Residential Amana LG4909W (BOM: P1163714W W) [Dryer Parts](#) Parts Diagram 12 - MTR CONN BLOCK/TERM & EXTRACTOR TOOL

[Click on the part number to view part](#)

Item	Original Part Number	Replaced By	Status	Part Description
1	00255		Not Available	(1/4 INCH-FOR (1) 12 GAUGE WIR
"	Y00256			Spade Terminal Or
2	500338			Housing-10 Position
3	Y00188			Molex Terminal
4	283P4			Terminal Extractor Tool
6	128P4		Not Available	(FOR USE ON GAS DRYER TERMINAL