

Amana LG8409L2 (BOM: PLG8409L2) 19 - REAR BLKHD/SEAL/CYLINDER ROLLER/TERM BLK

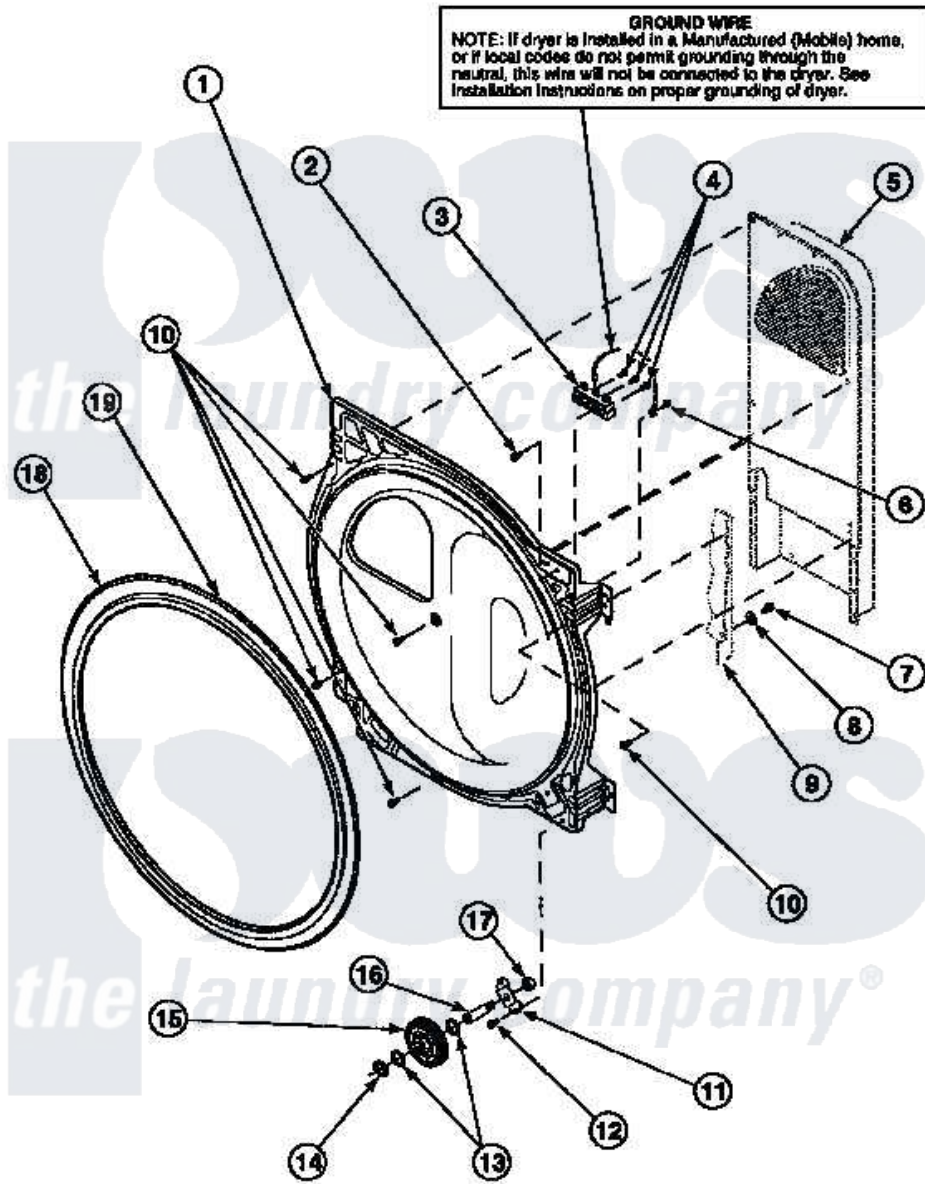

Amana Residential Amana LG8409L2 (BOM: PLG8409L2) Dryer Parts Parts Diagram 19 - REAR BLKHD/SEAL/CYLINDER ROLLER/TERM BLK
 Click on the part number to view part

Item	Original Part Number	Replaced By	Status	Part Description
1	502614W	502614WP		Bulkhead, Rear
"	Y501154		Not Available	ASSY, BULKHEAD
4	Y61199	3400094		Screw, 10-32 X 3/8
5	500179P	503605		Assembly, Heater Duct
6	20530			Screw, 10-24 x 3/8 Hex
7	20530			Screw, 10-24 x 3/8 Hex
8	51474		Not Available	WASHER, 13/64IDX1/2ODX.
9	500001P		Not Available	(ADD LETTER BEFORE "P" IN PART
10	501668	503688		Screw, 10B-16 X .34 I
11	500062	40113601		Assembly, Roller Brkt
12	501668	503688		Screw, 10B-16 X .34 I
13	52549			Washer, 501 ID X3/4 Odx
14	23748			Ring, Retaining
15	500214P	37001042		Assembly, Cylinder Roller

16

[56461](#)

Shaft

17

56156

[358160](#)

Nut

18

501801

[37001132](#)

Seal, Cylinder

19

22506P

[511637P](#)

Adh Dow 737 Clr 3 Oz Tube

