

Amana LG8459L2 (BOM: PLG8459L2) 03 - FR BLKHD, AIR DUCT, FELT SEAL & CYLINDER

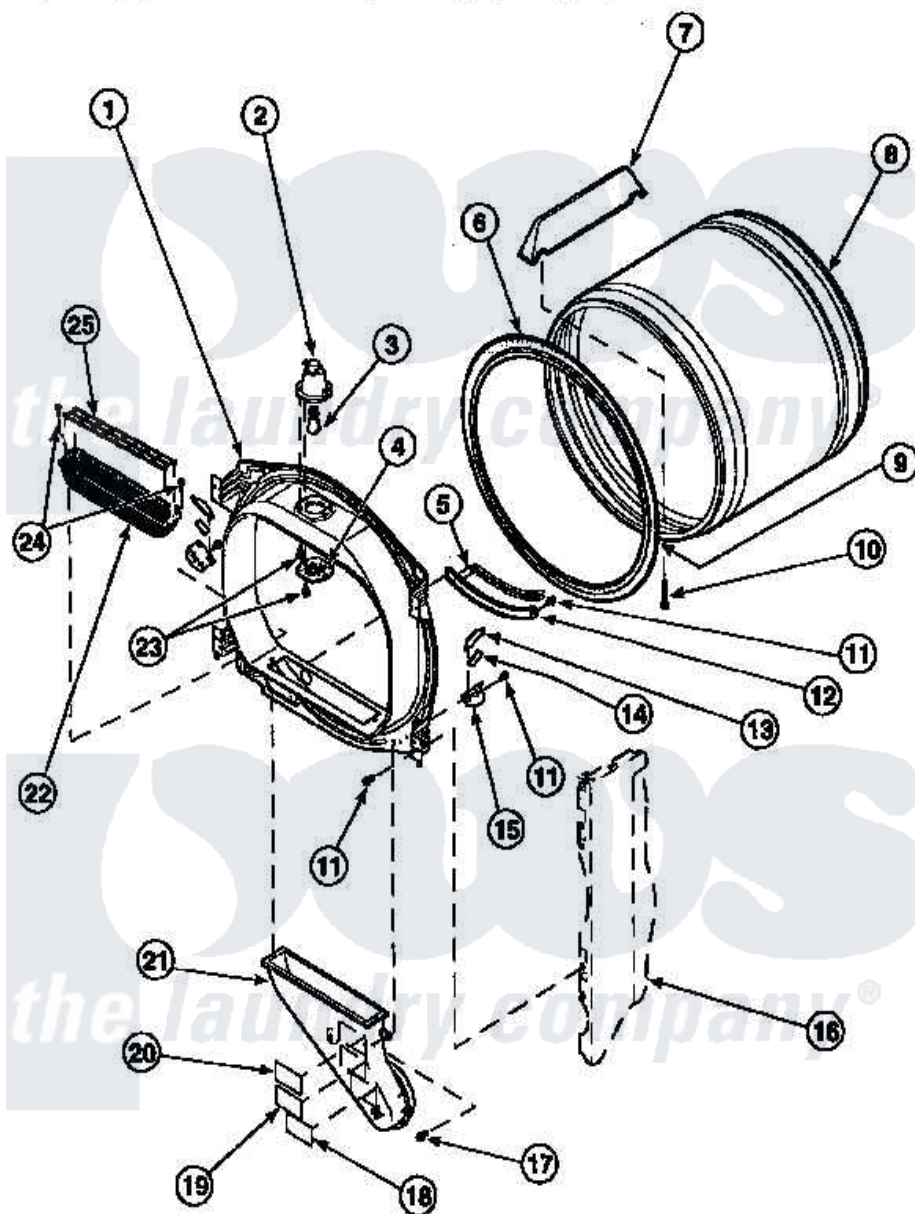

Amana Residential Amana LG8459L2 (BOM: PLG8459L2) Dryer Parts Parts Diagram 03 - FR BLKHD, AIR DUCT, FELT SEAL & CYLINDER

Click on the part number to view part

Item	Original Part Number	Replaced By	Status	Part Description
1	500016W			Assembly, Bulkhead Front Complete
2	500153		Not Available	CYLINDER LIGHT HOUSING
3	Y60954	67001316		Bulb, Light
4	500094		Not Available	LENS,DRUM LIGHT
6	501801	37001132		Seal, Cylinder
7	500022	510102		Baffle- SH
8	500013WP		Not Available	ASSY,CYLINDER-HOME-
9	22506P	511637P		Adh Dow 737 Clr 3 Oz Tube
10	Y62588			Screw, 10BT-12 X 1 Tap
13	Y501676	37001298		Glide- Dry
15	501554	12002090		Bracket
16	500001P		Not Available	(ADD LETTER BEFORE "P" IN PART
17	Y31645	27001200		Screw

18	56259	Not Available	STICKER
19	500049	Not Available	STICKER
21	502231	Not Available	DUCT, HEAT
22	502140P		Filter, Lint Kit
23	500248	M0211530	Screw-SM No.8-18 X 3/8"
24	500226		Screw, 8b-16 x 5/8 Tap
25	502092		Cover, Lint Filter

