

Amana LG8569W2 (BOM: PLG8569W2) 16 - REAR BLKHD/FELT SEAL/CYL ROLLER & TERM

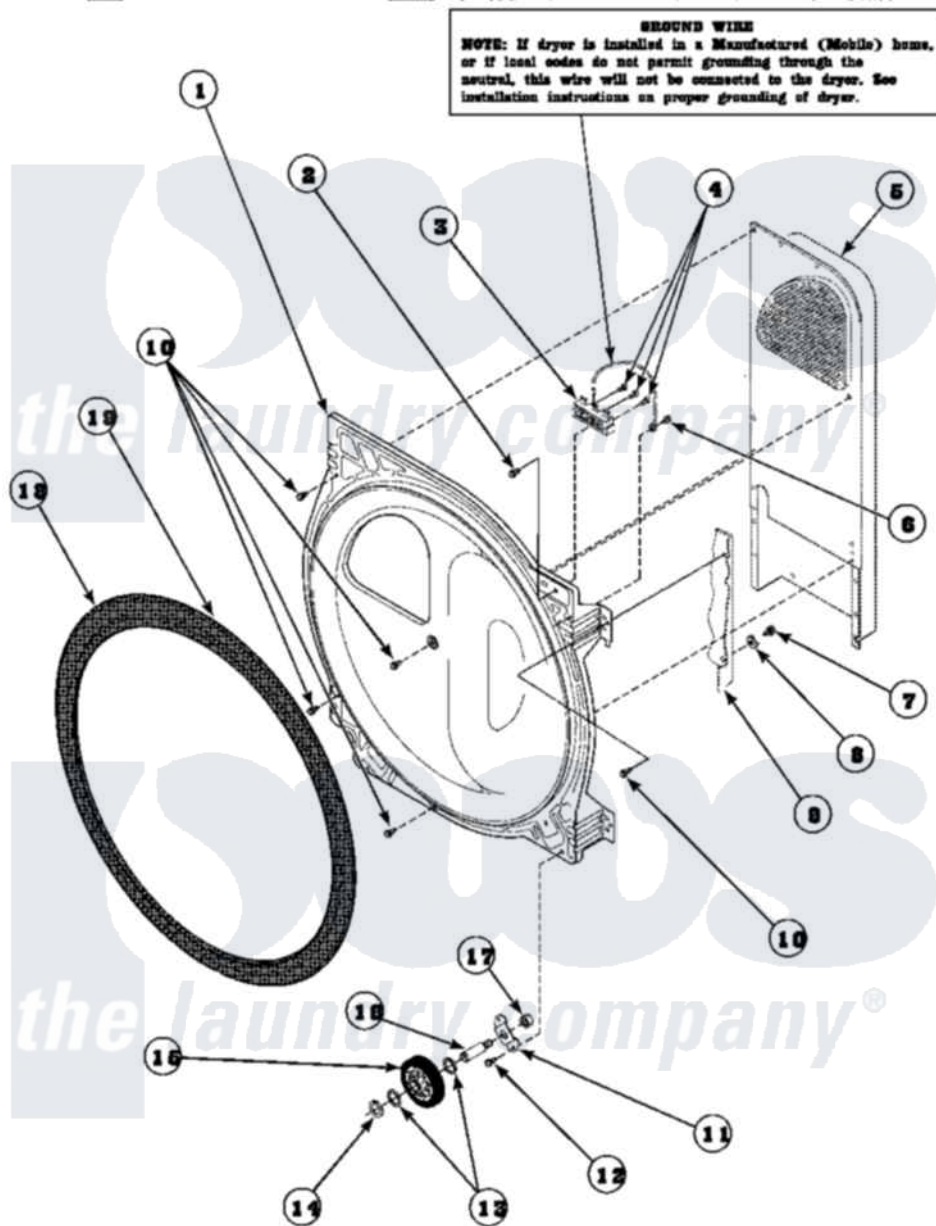

Amana Residential Amana LG8569W2 (BOM: PLG8569W2) Dryer Parts Parts Diagram 16 - REAR BLKHD/FELT SEAL/CYL ROLLER & TERM
 Click on the part number to view part

Item	Original Part Number	Replaced By	Status	Part Description
1	502614W	502614WP		Bulkhead, Rear
"	Y501154		Not Available	ASSY, BULKHEAD
2	501285			Screw, No.12 X 9/16-Pla
3	61923P	61923		Block, Terminal
4	Y61199	3400094		Screw, 10-32 X 3/8
5	500179P	503605		Assembly, Heater Duct
6	20530			Screw, 10-24 x 3/8 Hex
"	502120	489069		Xxscrew, 10-12 X 1/2
7	20530			Screw, 10-24 x 3/8 Hex
8	51474		Not Available	WASHER,13/64IDX1/2ODX.
9	500001P		Not Available	(ADD LETTER BEFORE "P" IN PART
10	501668	503688		Screw, 10B-16 X .34 I
11	500062	40113601		Assembly, Roller Brkt
12	502120	489069		Xxscrew, 10-12 X 1/2

13	52549	Washer, 501 ID X3/4 Odx	
14	23748	Ring, Retaining	
15	500214P	37001042	Assembly, Cylinder Roller
16	56461	Shaft	
17	56156	358160	Nut
18	501801	37001132	Seal, Cylinder
19	22506P	511637P	Adh Dow 737 Clr 3 Oz Tube

