

Amana LGA50AW (BOM: PLGA50AW) 10 - TERMINALS AND MOTOR CONNECTION BLOCK

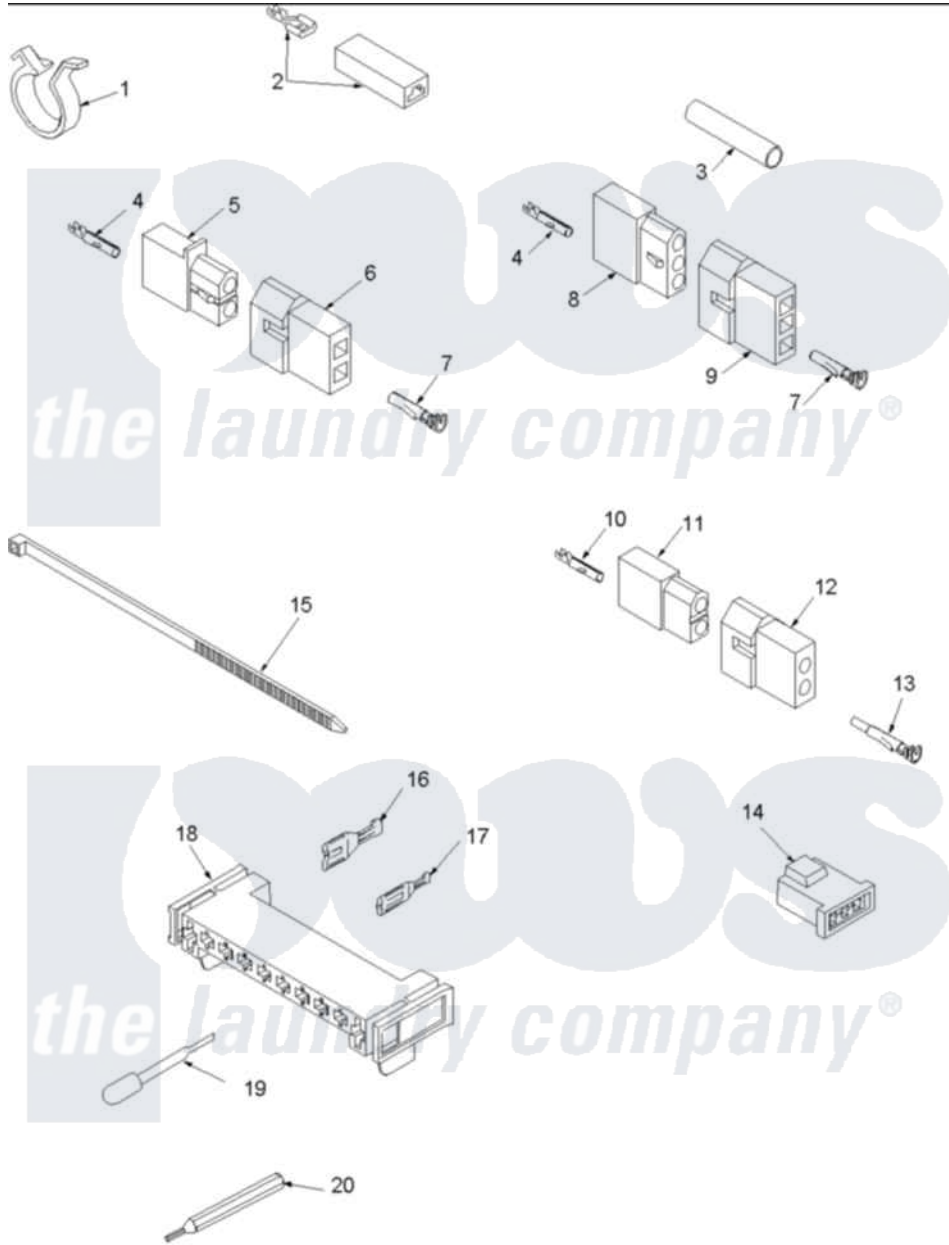

Amana [Residential Amana LGA50AW \(BOM: PLGA50AW\) Dryer Parts](#) Parts Diagram 10 - TERMINALS AND MOTOR CONNECTION BLOCK

[Click on the part number to view part](#)

Item	Original Part Number	Replaced By	Status	Part Description
1	504034			Clip, Wire
2	Y00237			Terminal-Female 1/4 ((1) 12 GAuge Wire Or(2) 18 GA
3	Y21365	503670		Sleeve Insulator
4	Y00117	5011-XX		093 Female Socket
5	56451			Receptacle, 2 Circuit
6	56448			Terminal Block Plug
7	Y00116			Terminal, Pin-Male
8	23039	697780		Receptacle,
9	23040			Plug-3 Circuit
10	00130			Terminal, Pin-1/8 Femal
11	56265			Receptacle, 2 Circuit
12	56266			Plug
13	Y00127			Terminal, Pin-1/8 Male
14	58800		Not Available	CONNECTOR-3 CIRCUIT (3

14	36466	M0321209	Not Available	CIRCUIT CONNECTOR)
15	36466			Tie-Electrical
16	Y00256			Spade Terminal Or
"	00255		Not Available	(1/4 INCH-FOR (1) 12 GAUGE WIR
17	Y00188			Molex Terminal
18	500338			Housing-10 Position
19	283P4			Terminal Extractor Tool
20	128P4		Not Available	(FOR USE ON GAS DRYER TERMINAL

