

Amana LGM449L (BOM: P1176704W L) 01 - BULKHEAD/FELT SEAL/CYL ROLLER & TERM BLK

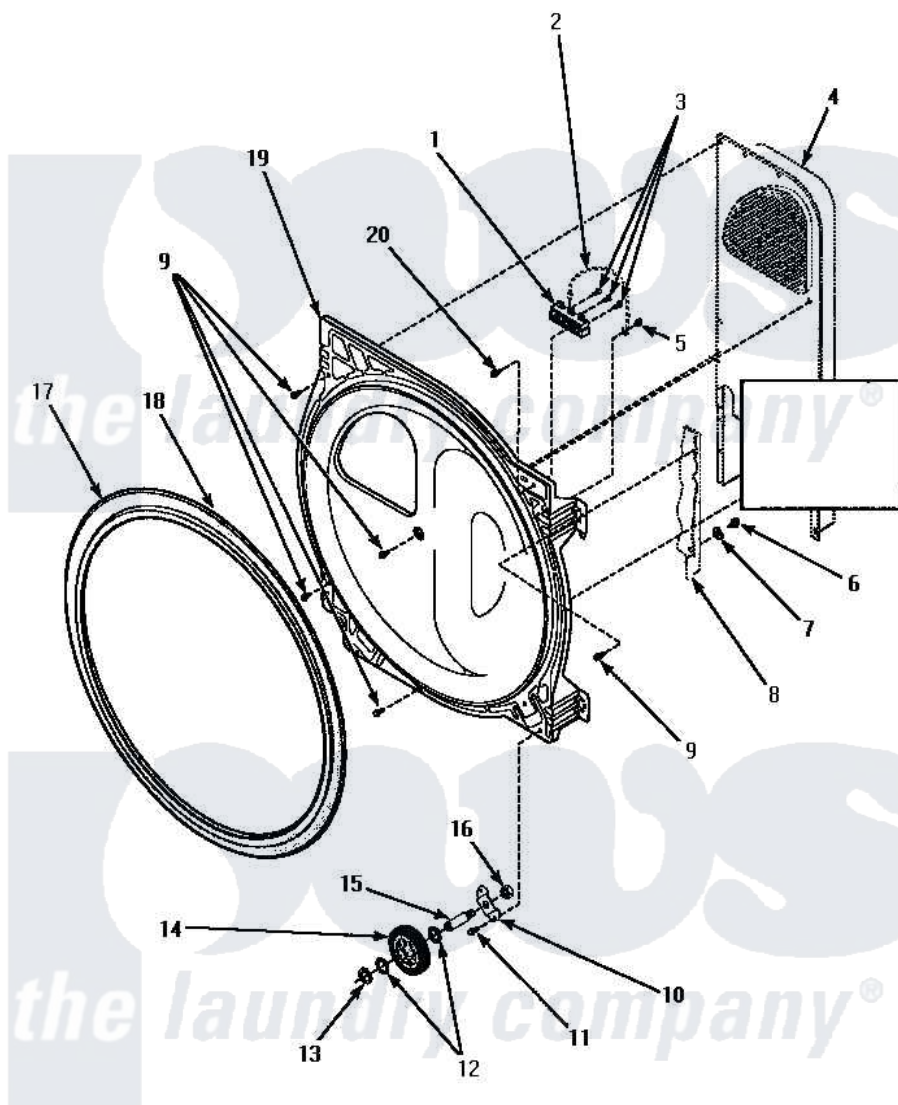

REAR BULKHEAD, FELT SEAL, CYLINDER ROLLER AND TERMINAL BLOCK

Amana [Residential Amana LGM449L \(BOM: P1176704W L\) Dryer Parts](#) Parts Diagram 01 - BULKHEAD/FELT SEAL/CYL ROLLER & TERM BLK
 Click on the part number to view part

Item	Original Part Number	Replaced By	Status	Part Description
1	61923P	61923		Block, Terminal
2	Y00000000		Not Available	SEE NOTE GROUND WIRE, GREEN -- (SEE NOTE)
3	Y61199	3400094		Screw, 10-32 X 3/8
4	Y00000000		Not Available	SEE NOTE HEATER BOX ASSEMBLY
5	20530			Screw, 10-24 x 3/8 Hex
6	20530			Screw, 10-24 x 3/8 Hex
7	51474		Not Available	WASHER, 13/64IDX1/2ODX.
8	Y00000000		Not Available	SEE NOTE CABINET
9	501668	503688		Screw, 10B-16 X .34 I
10	500062	40113601		Assembly, Roller Brkt
11	501668	503688		Screw, 10B-16 X .34 I
12	52549			Washer, 501 ID X3/4 Odx
13	23748			Ring, Retaining

14	500214	37001042	Assembly, Cylinder Roller
15	56461		Shaft
16	56156	358160	Nut
17	501801	37001132	Seal, Cylinder
18	22506P	511637P	Adh Dow 737 Clr 3 Oz Tube
19	500356W	502614WP	Bulkhead, Rear
20	501285		Screw, No.12 X 9/16-Pla

