

Amana LW3503L (BOM: P1163204W L) 08 - GRAPHIC PANEL, CTRL MTG PLATE & CTRLS

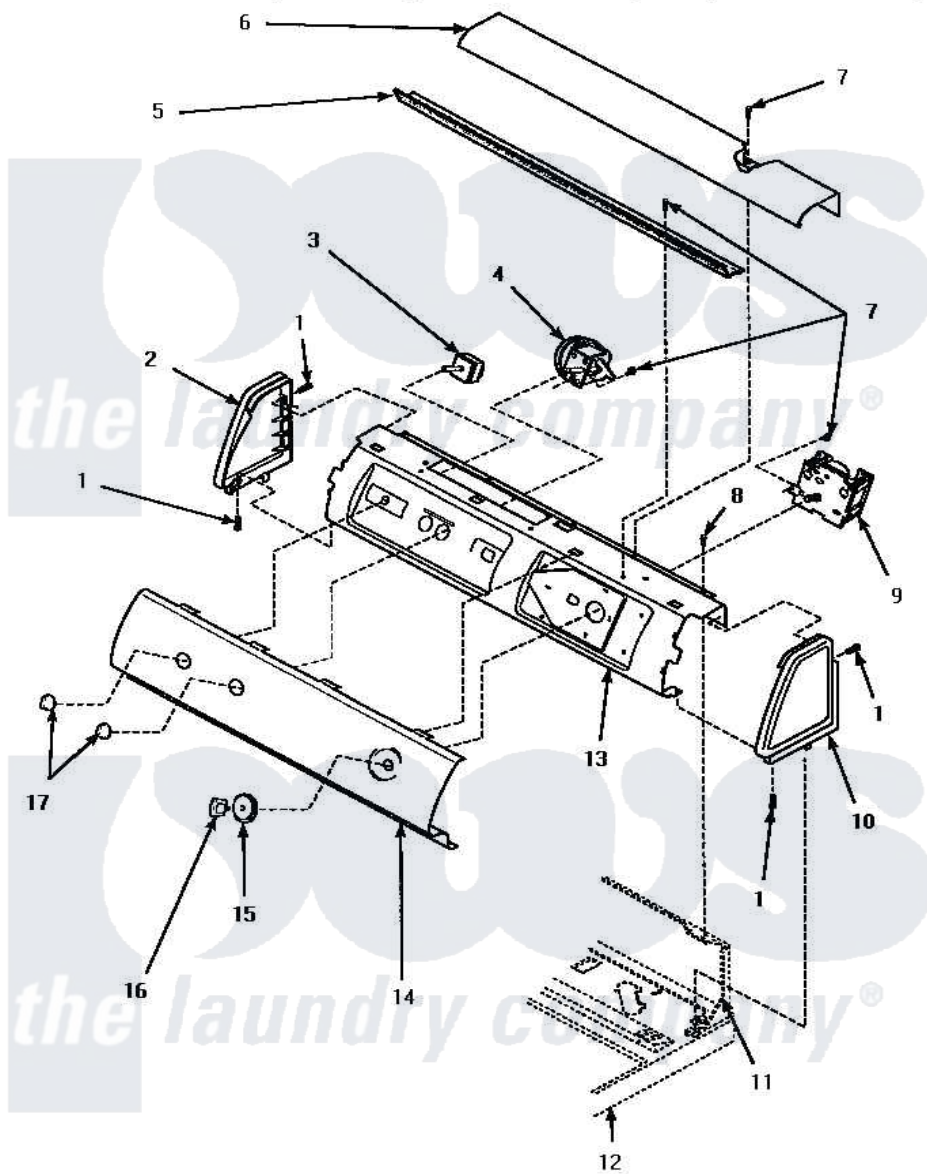

GRAPHIC PANEL, CONTROL MOUNTING PLATE AND CONTROLS

Amana [Residential Amana LW3503L \(BOM: P1163204W L\) Washer Parts](#) Parts Diagram 08 - GRAPHIC PANEL, CTRL MTG PLATE & CTRLS

[Click on the part number to view part](#)

Item	Original Part Number	Replaced By	Status	Part Description
"	NOTE:		Not Available	OUTER TUB COVER AND GASKET TOOL IS FOR REMOVAL OF 36025 OUTER TUB COVER FROM OUTER TUB AND INSTALLATION OF 32857 GASKET IN OUTER TUB COVER.
1	501086	90767		Screw, 8A X 3/8 HeX Washer Head Tapping
2	34816			Panel, End
3	35115			Switch, TemPerature 3 P
4	36045	40055101		Switch, Pressure
5	Y34826		Not Available	DIFFUSER,LAMP-CLEAR
6	34823		Not Available	COVER, TOP
7	23962	W10116760		Screw
8	34904	489355		Screw, 8 X 1/2
9	31239	31239P		Timer 3 Cycle Package

10	34815	Not Available	PANEL, END R.H. (BLK)
11	Y00000000	Not Available	SEE NOTE CONTROL HOOD REAR PANEL
12	Y00000000	Not Available	SEE NOTE CABINET TOP
13	34821	Not Available	CONTROL MOUNTING PLATE
14	35317	Not Available	PANEL,GRAPHIC-AMANA
15	34848		Assembly, Timer Skirt
16	34844	Not Available	KNOB,TIMER
17	34847		Assembly, Knob-Rotary

