

Amana LW3503L2 (BOM: PLW3503L2 A) 27 - TRANSMISSION ASSY AND BALANCE RING

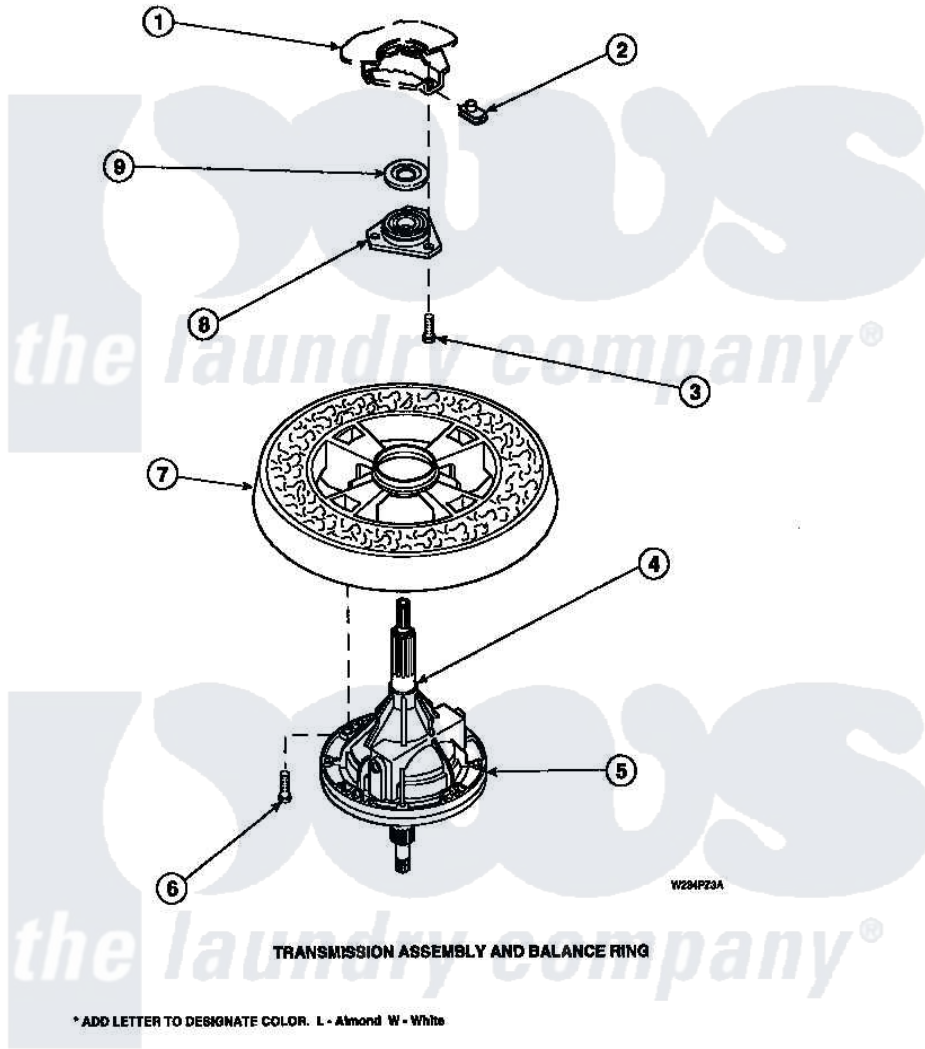

Amana Residential Amana LW3503L2 (BOM: PLW3503L2 A) Washer Parts Parts Diagram 27 - TRANSMISSION ASSY AND BALANCE RING

Click on the part number to view part

Item	Original Part Number	Replaced By	Status	Part Description
1	34438P			Assembly, Outer Tub
2	27222			Nut, Retainer 5/16-18
3	36991	3400500		Bolt, 3405245 5/16-18 X 3/4
4	27604P			Never-Seeze 1 Oz Tube
5	34526P			Assembly, Transmission
6	37047		Not Available	SCREW, CAP
7	34731		Not Available	ASSY,BALANCE RING-COMPL
8	27182	40004201P		Main Bearing Assembly
9	27187			Flinger