

# Amana LW4302L (BOM: P1163302W L) 14 - OUT-OF-BALANCE SWITCH

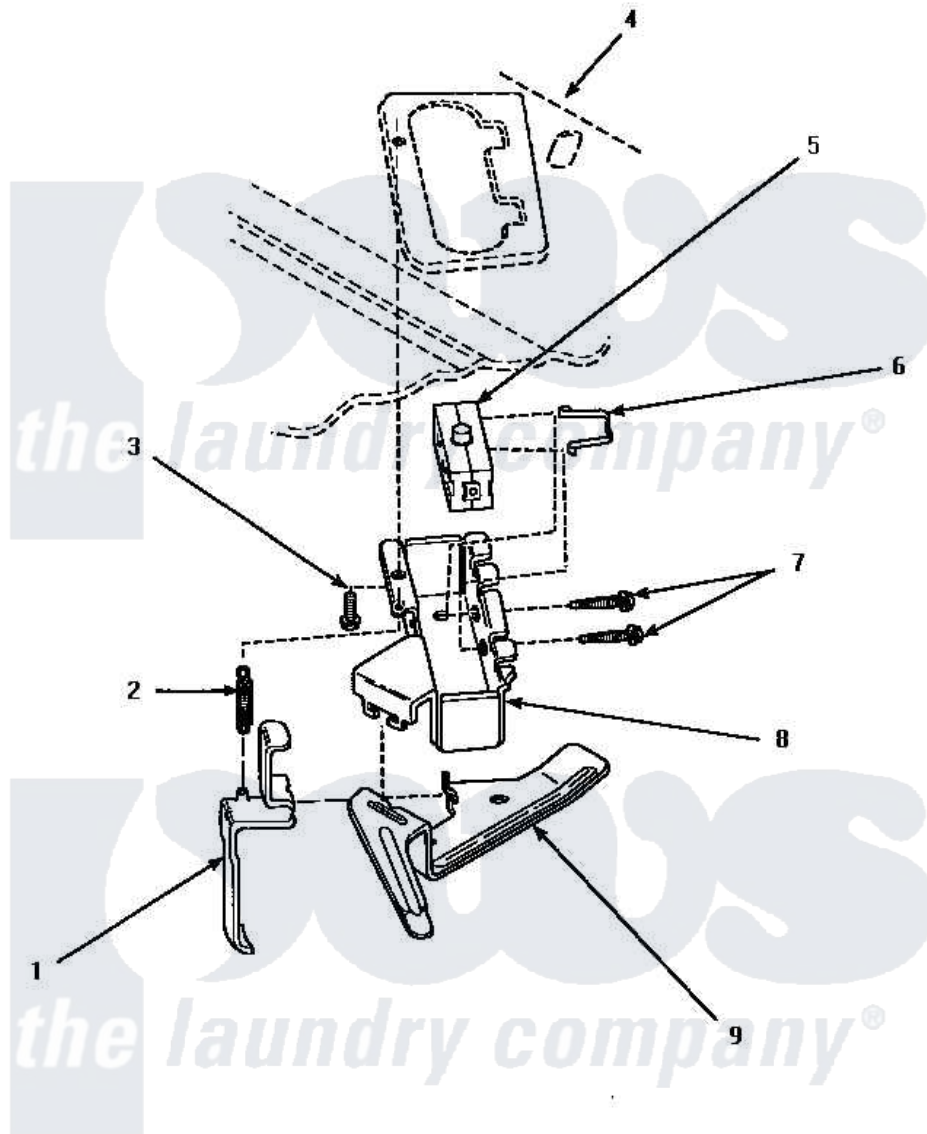

## OUT-OF-BALANCE SWITCH

Amana Residential Amana LW4302L (BOM: P1163302W L) Washer Parts Parts Diagram 14 - OUT-OF-BALANCE SWITCH

[Click on the part number to view part](#)

Item	Original Part Number	Replaced By	Status	Part Description
1	<a href="#">33442</a>			Lever, Unbalanced Load
2	<a href="#">33443</a>			Spring
3	23962	<a href="#">W10116760</a>		Screw
4	Y00000000		Not Available	SEE NOTE CABINET TOP
5	33445	<a href="#">27001095</a>		Switch, Lid
6	33433		Not Available	CLIP,HOLDER-SWITCH
7	<a href="#">36510</a>			Screw
8	<a href="#">36497P</a>			Kit, Switch Holder
9	<a href="#">33441</a>			Arm, Actuator