

Amana LW4303W (BOM: P1163303W W) 14 - OUT-OF-BALANCE SWITCH

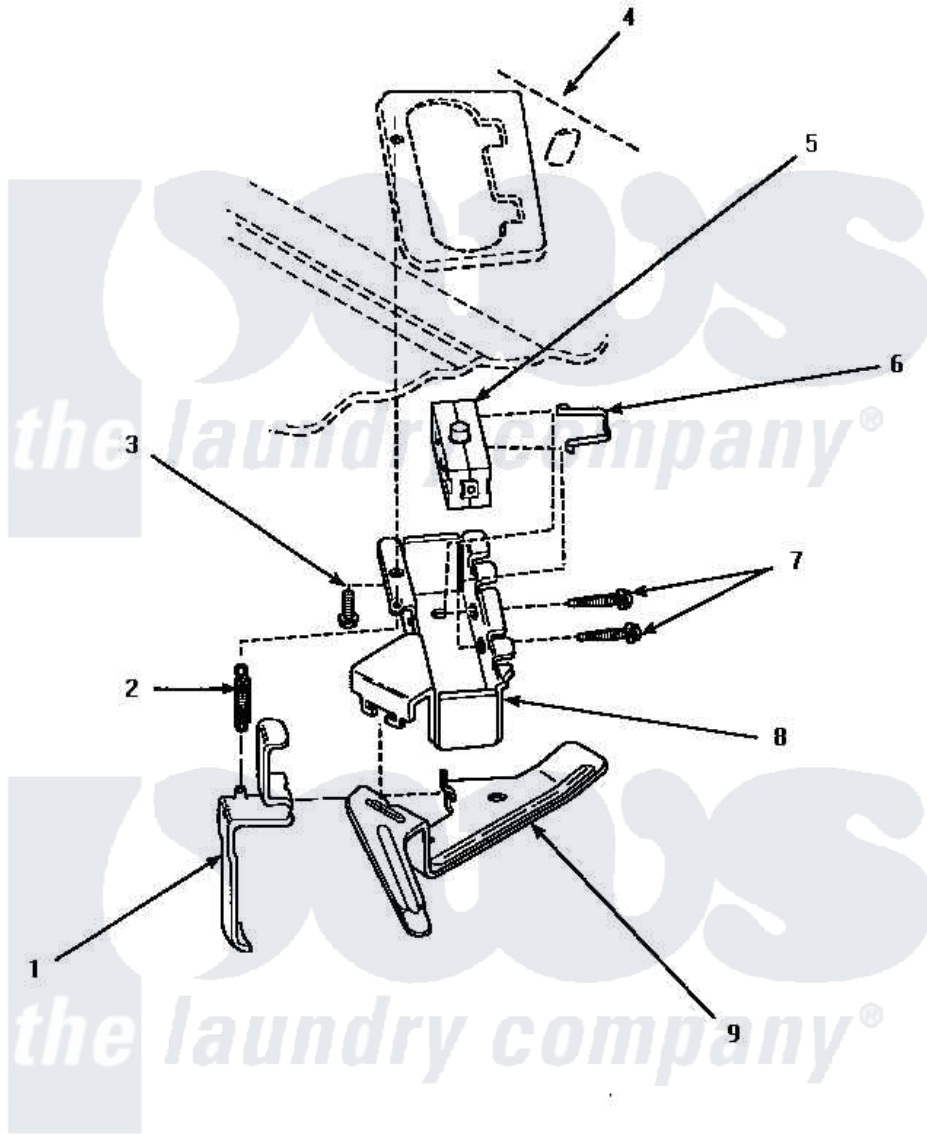

OUT-OF-BALANCE SWITCH

Amana [Residential Amana LW4303W \(BOM: P1163303W W\) Washer Parts](#) Parts Diagram 14 - OUT-OF-BALANCE SWITCH

[Click on the part number to view part](#)

Item	Original Part Number	Replaced By	Status	Part Description
1	33442			Lever, Unbalanced Load
2	33443			Spring
3	23962	W10116760		Screw
4	Y00000000		Not Available	SEE NOTE CABINET TOP
5	33445	27001095		Switch, Lid
6	33433		Not Available	CLIP,HOLDER-SWITCH
7	36510			Screw
8	36497P			Kit, Switch Holder
9	33441			Arm, Actuator