

Amana LW4603L (BOM: P1163404W L) 03 - BRG HSG/BRAKE/PULLEY & PIVOT DOME

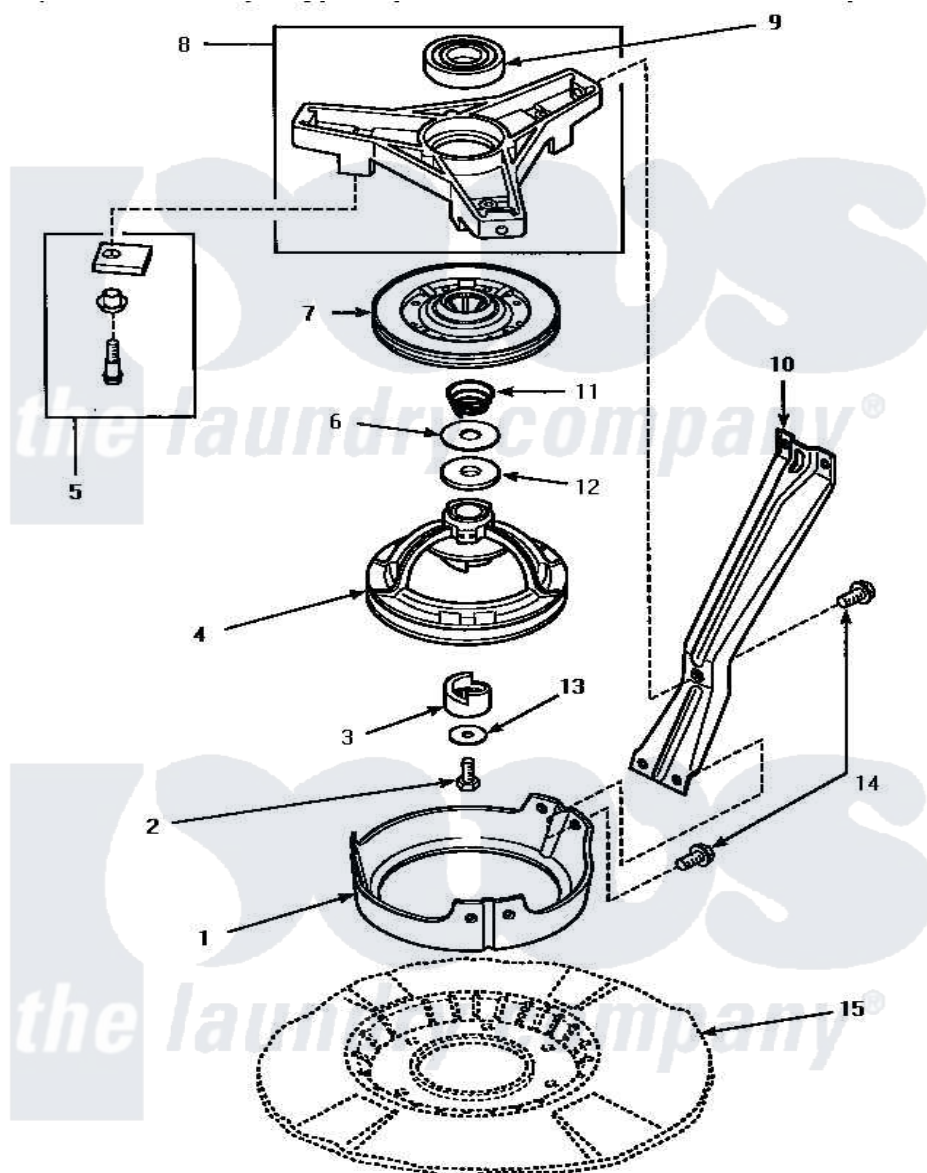

BEARING HOUSING, BRAKE, PULLEY AND PIVOT DOME

Amana Residential Amana LW4603L (BOM: P1163404W L) Washer Parts Parts Diagram 03 - BRG HSG/BRAKE/PULLEY & PIVOT DOME
 Click on the part number to view part

Item	Original Part Number	Replaced By	Status	Part Description
1	34470			Dome, Pivot
2	27220	40063401		Screw, 1/4-20 x 5/8 Hex
3	27018			Helix
4	34921			Assembly, Pulley-Spin And Agitate
5	548P3	R9900543		Pad-Brake
6	35535	40065701		Washer, 2 Odx.63 ID
7	31961P	R9900474		Brake Assembly
8	35746			Assembly, Bearing Housing-L
9	28944R	40004001		Bearing, Main
10	34471		Not Available	LEG,SUPPORT
11	33435			Spring, Conical
12	27015	40063201		Washer, Flat
13	26509	40041501		Washer
14	35369	40128701		Screw, 5/16-18 X .50

