

Amana LW8201L2 (BOM: PLW8201L2 A) 17 - INLET/FILL HOSE & MIXING VLV MTG BRKT

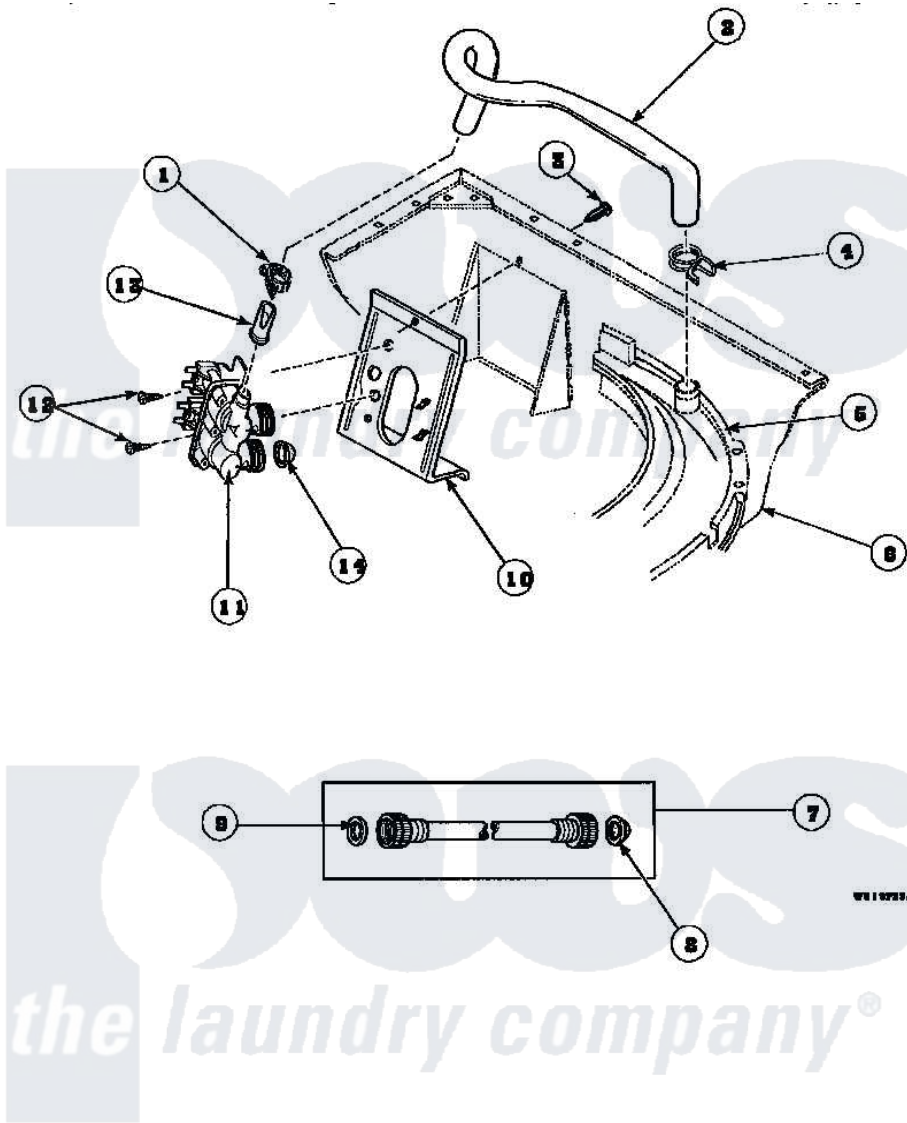

Amana Residential Amana LW8201L2 (BOM: PLW8201L2 A) Washer Parts Parts Diagram 17 - INLET/FILL HOSE & MIXING VLV MTG BRKT
 Click on the part number to view part

Item	Original Part Number	Replaced By	Status	Part Description
1	36801	596669		Clamp, Manifold
2	35874	38155		Hose, Mix Valve To TU
3	33562	27001200		Screw
4	29210			Hose Clamp
5	36025P			Assembly, Tub Coverand Gasket
6	34475P		Not Available	CABINET
7	20618	21001467		Hose- 10'
"	20617		Not Available	HOSE, INLET (8 FT)
"	28330P	202860		Inlet Hose Assembly
8	28605	22002960		Strainer, Washer Inlet
9	20290	Y013783		Washer, Inlet Hose
10	34972	39407		Bracket, Valve
11	34963	34963P		Valve Mixing Package
12	501086	00767		Screw, 8A X 3/8 HeX Washer

