

Amana LW8203L2 (BOM: PLW8203L2 A) 22 - OUT-OF-BALANCE SWITCH

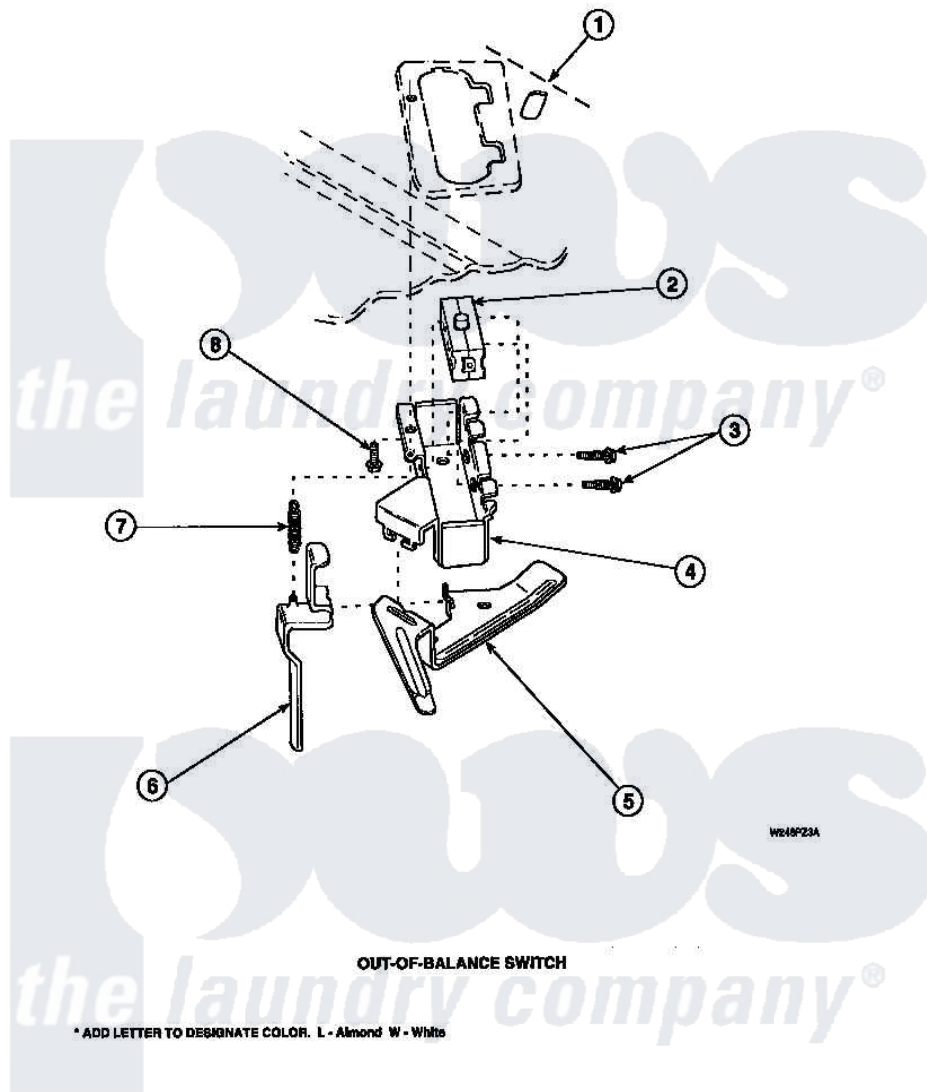

Amana [Residential Amana LW8203L2 \(BOM: PLW8203L2 A\) Washer Parts](#) Parts Diagram 22 - OUT-OF-BALANCE SWITCH

[Click on the part number to view part](#)

| Item | Original Part Number | Replaced By | Status | Part Description |
|------|------------------------|---------------------------|---------------|------------------------|
| 1 | 34902P | | Not Available | TOP |
| 2 | 33445 | 27001095 | | Switch, Lid |
| 3 | 36510 | | | Screw |
| 4 | 36497P | | | Kit, Switch Holder |
| 5 | 33441 | | | Arm, Actuator |
| 6 | 33442 | | | Lever, Unbalanced Load |
| 7 | 33443 | | | Spring |
| 8 | 23962 | W10116760 | | Screw |