

**Amana LW8203L2 (BOM: PLW8203L2 B) 04 - BRG HSG/BRAKE PULLEY & PIVOT DOME**

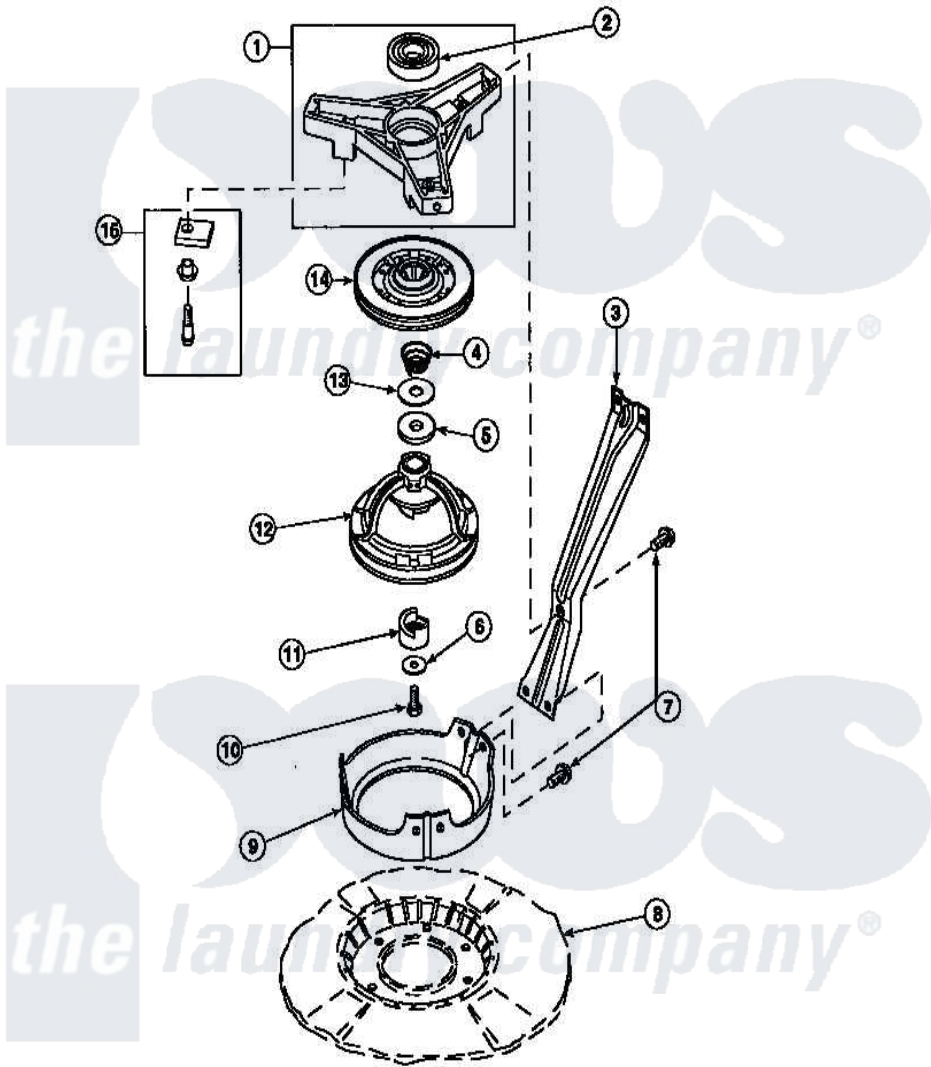

Amana Residential Amana LW8203L2 (BOM: PLW8203L2 B) Washer Parts Parts Diagram 04 - BRG HSG/BRAKE PULLEY & PIVOT DOME  
 Click on the part number to view part

Item	Original Part Number	Replaced By	Status	Part Description
1	<a href="#">35746</a>			Assembly, Bearing Housing-L
2	28944R	<a href="#">40004001</a>		Bearing, Main
3	34471		Not Available	LEG,SUPPORT
4	<a href="#">33435</a>			Spring, Conical
5	27015	<a href="#">40063201</a>		Washer, Flat
6	26509	<a href="#">40041501</a>		Washer
7	35369	<a href="#">40128701</a>		Screw, 5/16-18 X .50
8	<a href="#">36599P</a>			Assembly Nut/ Leg Base
"	<a href="#">34434P</a>			Assembly Nut/Leg Base
9	<a href="#">34470</a>			Dome, Pivot
10	27220	<a href="#">40063401</a>		Screw, 1/4-20 x 5/8 Hex
11	<a href="#">27018</a>			Helix
12	<a href="#">34921</a>			Assembly, Pulley-Spin And Agitate
13	35535	<a href="#">40065701</a>		Washer, 2 Odx.63 ID

