

Amana LW8303W2 (BOM: PLW8303W2 A) 11 - MOTOR, MTG BRKT, BELT, PUMP & IDLER ASSY

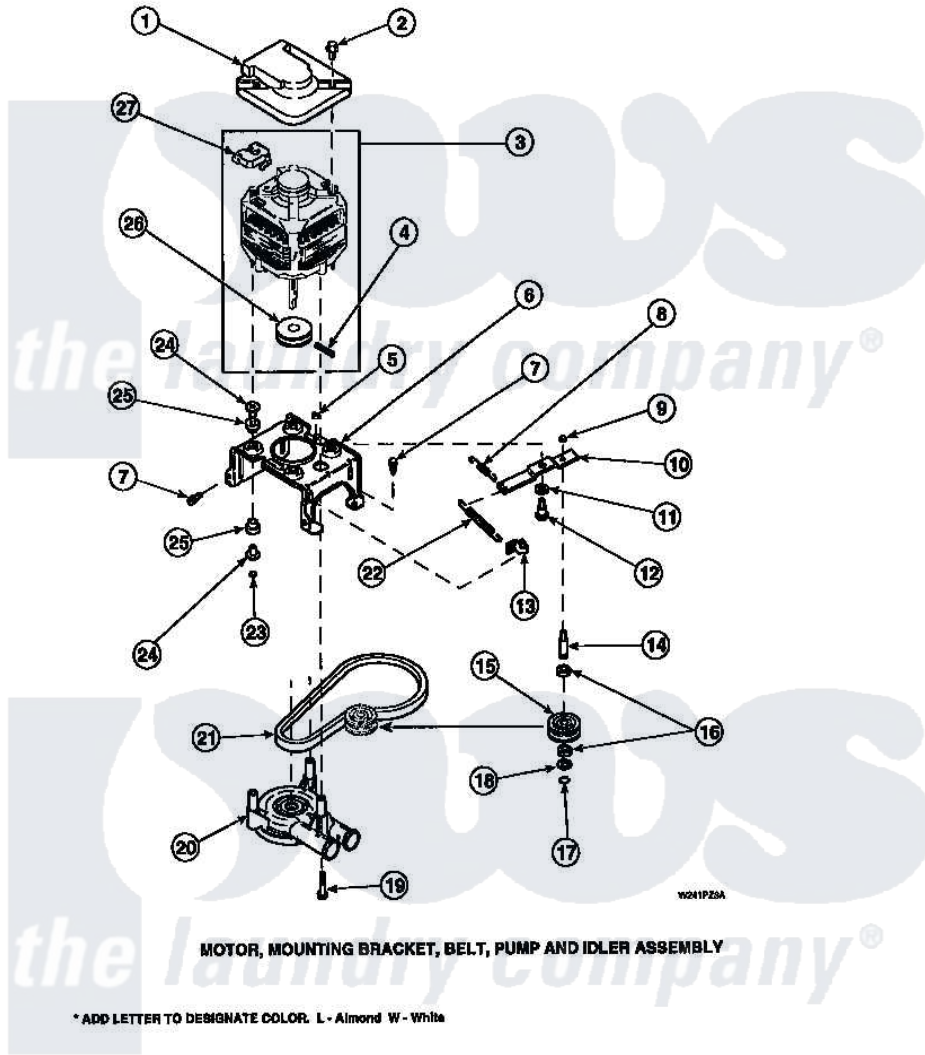

Amana Residential Amana LW8303W2 (BOM: PLW8303W2 A) Washer Parts Parts Diagram 11 - MOTOR, MTG BRKT, BELT, PUMP & IDLER ASSY
 Click on the part number to view part

| Item | Original Part Number | Replaced By | Status | Part Description |
|------|------------------------|--------------------------|---------------|--------------------------|
| 1 | 34754 | 40112301 | | Shield, Motor |
| 2 | 36639 | 4312464 | | Screw |
| 3 | 34571P | 27001215 | | Motor W/Pulley |
| 4 | 23750 | | | Pin, Roll |
| 5 | 52566 | 27001225 | | Nut, Jam Mid Lock 1/4-20 |
| 6 | 34890 | | Not Available | BRACKET, MOTOR MOUNT |
| " | 37415P | | | Kit, Motor Brkt |
| " | 37415 | 37415P | | Kit, Motor Brkt |
| 7 | Y31645 | 27001200 | | Screw |
| 8 | 30620 | | Not Available | SPRING, IDLER LEVER HEL |
| 9 | 28803 | 2221070 | | Clamp, Nylon |
| 10 | 31054 | 40041002 | | Lever, Idler |
| " | 37443 | 40041002 | | Lever, Idler |
| 11 | 81392 | 40054701 | | Washer |
| 12 | 27229 | 40038901 | | Screw, 1/4-20 |

| | | | |
|----|------------------------|--------------------------|-------------------------|
| 13 | 28849 | | Clip, Spring |
| 14 | 28802 | | Shaft, Idler |
| 15 | 28800 | Not Available | WHEEL, IDLER |
| 16 | Y29443 | | Washer, Felt |
| 17 | 23748 | | Ring, Retaining |
| 18 | 52549 | | Washer, 501 ID X3/4 Odx |
| 19 | Y34565 | 40063701 | Screw, 10-16 x 1.75 |
| 20 | 36863P | 27001233 | Pump |
| 21 | 28808 | | Belt, Agitate And Spin |
| 22 | 37366 | | Spring, Idler |
| " | 37606 | | Spring, Idler Lever |
| 23 | 35423 | 3400029 | Nut, Adapter Plate |
| 24 | 34791 | | Post, Mount-Motor |
| 25 | 34788 | | Mount, Motor |
| 26 | 27171 | Not Available | PULLEY, MOTOR |
| 27 | 35632 | Not Available | SWITCH, MOTOR |

