

# Amana LW8303W2 (BOM: PLW8303W2 B) 15 - OUT-OF-BALANCE SWITCH

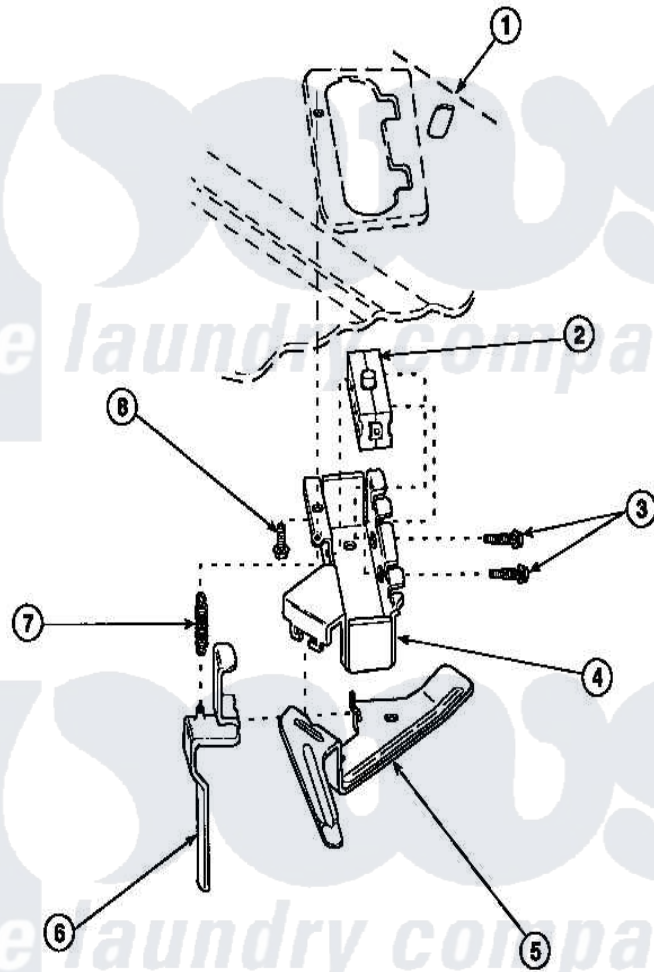

Amana Residential Amana LW8303W2 (BOM: PLW8303W2 B) Washer Parts Parts Diagram 15 - OUT-OF-BALANCE SWITCH

[Click on the part number to view part](#)

Item	Original Part Number	Replaced By	Status	Part Description
1	34902P		Not Available	TOP
2	33445	<a href="#">27001095</a>		Switch, Lid
3	<a href="#">36510</a>			Screw
4	<a href="#">36497P</a>			Kit, Switch Holder
5	<a href="#">33441</a>			Arm, Actuator
6	<a href="#">33442</a>			Lever, Unbalanced Load
7	<a href="#">33443</a>			Spring
8	23962	<a href="#">W10116760</a>		Screw