

Amana LW8413W2 (BOM: PLW8413W2 B) 04 - BRG HSG/BRAKE PULLEY & PIVOT DOME

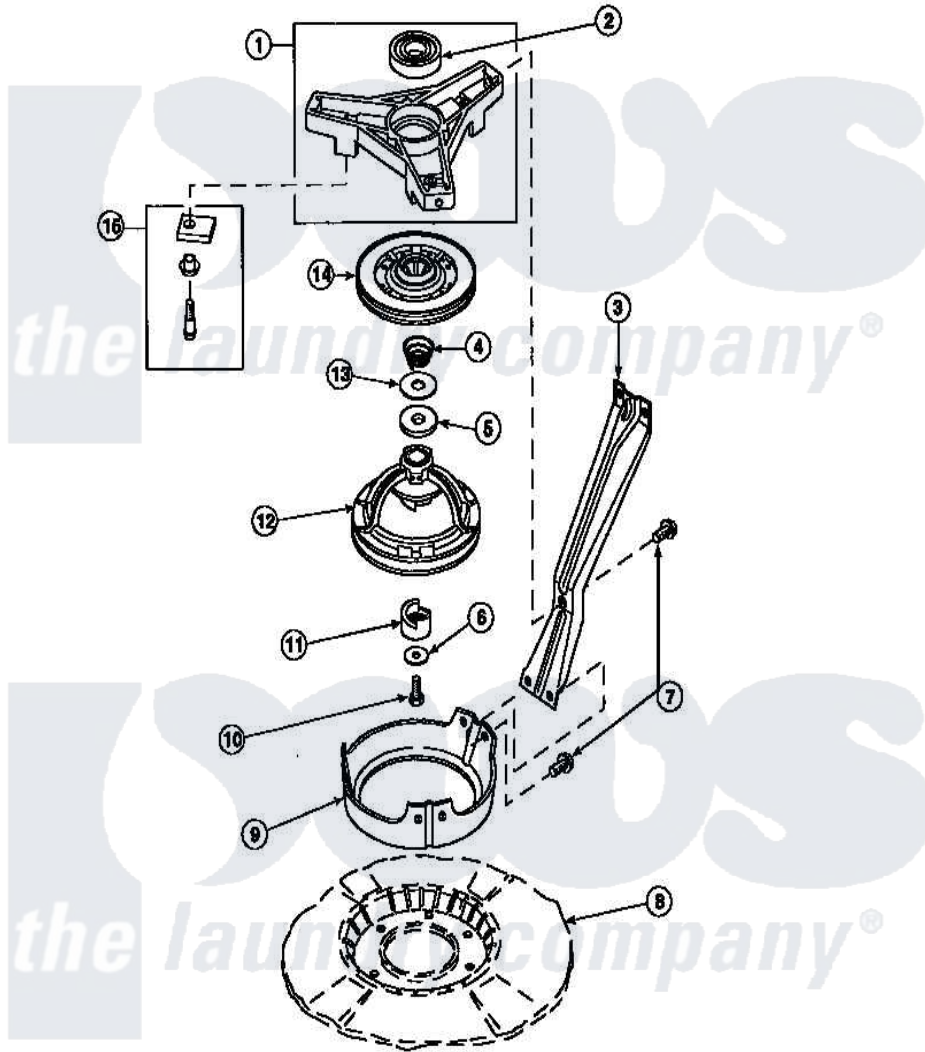

Amana Residential Amana LW8413W2 (BOM: PLW8413W2 B) Washer Parts Diagram 04 - BRG HSG/BRAKE PULLEY & PIVOT DOME

Click on the part number to view part

Item	Original Part Number	Replaced By	Status	Part Description
1	35746			Assembly, Bearing Housing-L
2	28944R	40004001		Bearing, Main
3	34471		Not Available	LEG,SUPPORT
4	33435			Spring, Conical
5	27015	40063201		Washer, Flat
6	26509	40041501		Washer
7	35369	40128701		Screw, 5/16-18 X .50
8	36599P			Assembly Nut/ Leg Base
"	34434P			Assembly Nut/Leg Base
9	34470			Dome, Pivot
10	27220	40063401		Screw, 1/4-20 x 5/8 Hex
11	27018			Helix
12	34921			Assembly, Pulley-Spin And Agitate
13	35535	40065701		Washer, 2 Odx.63 ID

