

Amana LWA65AL (BOM: PLWA65AL) 02 - BEARINGS, BRAKE & PULLEY & TRANSMISSION

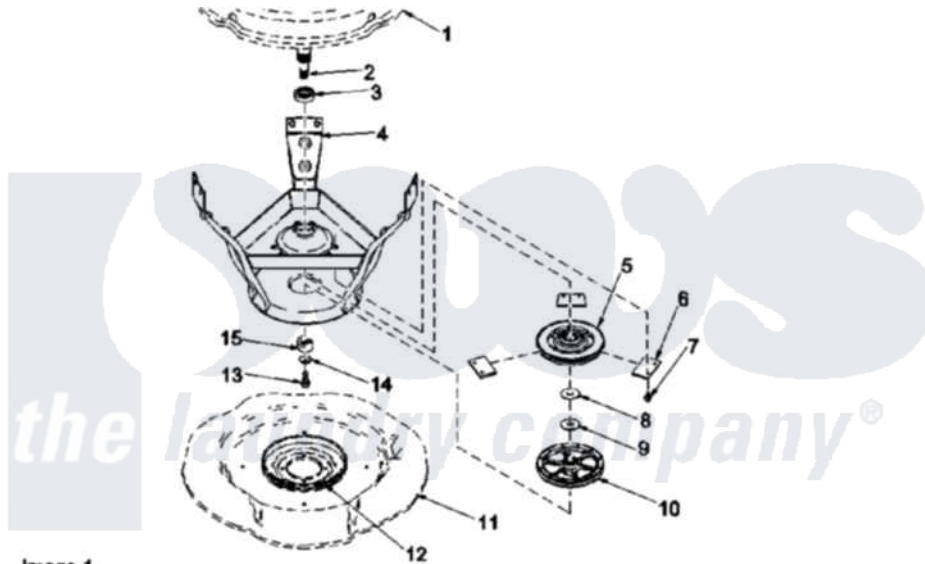
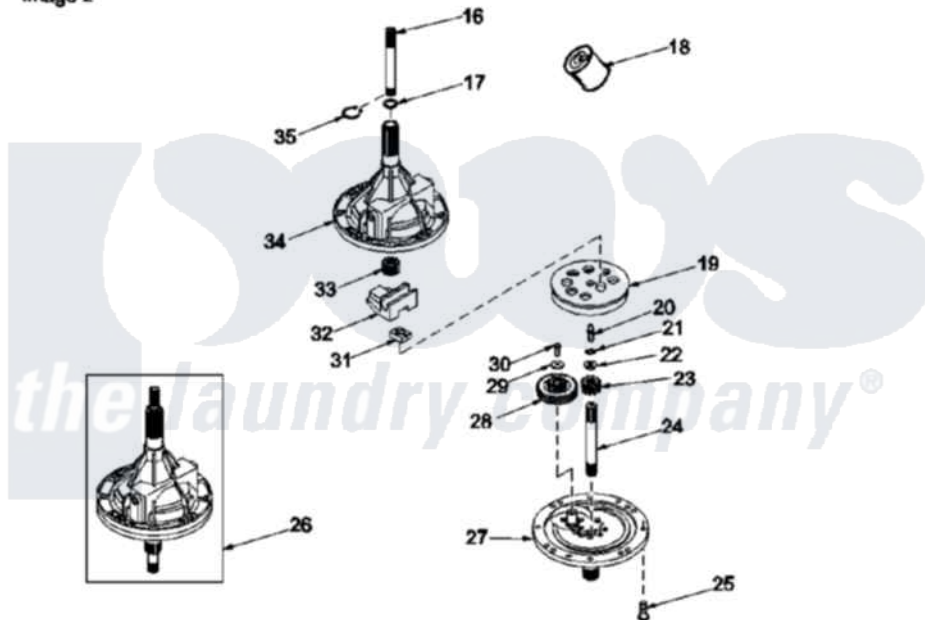

Image 1

Image 2



Amana Residential Amana LWA65AL (BOM: PLWA65AL) Washer Parts Parts Diagram 02 - BEARINGS, BRAKE & PULLEY & TRANSMISSION

[Click on the part number to view part](#)

Item	Original Part Number	Replaced By	Status	Part Description
1	37981P			Tub-Outer-Short
2	38826P	12002178		Transmison
3	28944R	40004001		Bearing, Main
4	39253			Assembly, Weld And Bearing
5	38505	R9900474		Brake Assembly
6	637P3	R0000014		Kit, Brake Pad
7	37836	40064401		Screw
8	35535	40065701		Washer, 2 Odx.63 ID
9	27015	40063201		Washer, Flat
10	Y38007	40047202		Pulley, Spin
11	37807	39788		Assembly- Base
12	37937	40037401		Ring, Friction
13	27220	40063401		Screw, 1/4-20 x 5/8 Hex
14	26509	40041501		Washer
15	Y38008	40047402		Helix, Plastic

16	Y36570		Shaft, Output
17	35092		Washer, 3628id X 1.00 X .056
18	27243P		Oil, CW Transmission F-
19	26577		Assembly, Gear And Stud
20	27030	Not Available	SCREW, 1/4-20 SPECIAL
21	21456		Lockwasher, 1/4 Intshkp
22	26509	40041501	Washer
23	37405	Not Available	PINION, DRIVE
24	38268		Shaft, Input
25	32814	Not Available	SCREW, 1/4-20X7/8 SERRA
26	Y37471		Assembly, Transmission Cover
27	38826P	12002178	Transmison
28	37403		Gear, Reduction
29	29260	Not Available	WASHER
30	29273		Screw, 1/4-20 X 3/8
31	Y31526		Rack
32	26493		Slide
33	27003		Pinion, Agitator
34	33223	Not Available	ASSY, TRANSMISSION CASE
35	27197		Ring, Retaining
NI	37577P	Not Available	SEALANT

